

duplex««
radio control system

DC-16, DS-16, DS-14

1. Introduction	07
1.1 DC/DS	07
1.2 DS-14	07
1.2.1 Activation method for software modules of JETI model	08
1.3 Features	09
1.4 Table of Contents	10
1.5 Technical Support	11
1.6 DC-16 Package Contents	11
1.7 DS-16 Package Contents	12
1.8 DS-14 Package Contents	12
2. System Specifications	13
2.1 DC-16	13
2.2 DS-16	13
2.3 DS-14	14
3. Description of Transmitter DC-16	15
3.1 Control Identification	15

3.2 Assembly Identification	16
3.3 Control Stick Assembly	17
3.3.1 Control Stick Length Adjustment	17
3.3.2 Swivel Control Stick Adjustment	17
3.3.3 Control Stick Tension Adjustment	18
3.3.4 Ratchet Tension Adjustment	18
3.3.5 Throttle stick travel adjustment	19
3.3.6 Transmitter Mode Switch	19
3.3.7 Transmitter Gimbals with Switch or Button Installation	20
3.4 Swappable and Assignable Switches	22
3.5 Digital Trims	23
3.6 Transmitter Battery Pack	24
3.6.1 Charging	24
3.6.2 Battery Replacement	24
3.7 PPM Output Connector	25
3.8 Handling	25

4. Description of Transmitter DS-16 26

4.1 Control Identification 26

4.2 Control Identification DS-14 27

4.3 Assembly Identification 28

4.4 Control Stick Assembly 29

4.4.1 Control Stick Length Adjustment 29

4.4.2 Swivel Control Stick Adjustment 29

4.4.3 Control Stick Tension Adjustment 30

4.4.4 Ratchet Tension Adjustment 31

4.4.5 Throttle stick travel adjustment 31

4.4.6 Transmitter Mode Switch 33

4.4.7 Transmitter Gimbals with Switch or Button Installation
..... 34

4.5 Swappable and Assignable Switches 37

4.5.1 Switch Removal Procedure 38

4.5.2 Assembly Procedure 38

4.6 Digital Trims 39

4.7 Transmitter Battery Pack 40

4.7.1 Charging 40

4.7.2 Battery Replacement 40

4.8 PPM Output Connector 41

4.9 Handling 41

5. RF Transmitter Modules 42

6. Transmitter Powering ON/OFF 43

6.1 Transmitter, Powering-ON 43

6.2 Transmitter Turning-OFF 43

6.3 Transmitter Restart 43

7. Initial switching-on 44

7.1 Main display 44

7.2 Navigation in the Menu 44

7.2.1 Browsing through the Menu 46

7.2.2 Basic Menu Structure 46

7.3 Model Set-up Guide 47

7.3.1 Airplane 47

7.3.2 Helicopter	49	8.8 RC-Switch	65
7.3.3 General	51	9. Main menu	67
7.3.4 Set up of Receiver Outputs	53	9.0.1 Password protection against accidental configuration changes	68
8. Duplex Receivers	55	9.1 Model	69
8.1 Description	55	9.1.1 Model Selection	69
8.2 Installation	55	9.1.2 New Model	70
8.3 Binding	55	9.1.3 Basic configuration- AIRPLANE	71
8.3.1 Standard pairing procedure	55	9.1.4 Basic Configuration - HELICOPTER	72
8.3.2 Alternative pairing procedure through the transmitter menu	56	9.1.5 Swash mix	74
8.4 Range test	56	9.1.6 Basic Configuration-GENERAL	74
8.5 Fail safe	56	9.1.7 Assignment of functions	75
8.6 Technical data receivers	58	9.1.8 Servo Assignment	76
8.6.1 Technical data receivers outside the U.S.	58	9.1.9 Servo Setup	77
8.6.2 Technical data receivers for the U.S.	59	9.1.10 Servo balancer	78
8.7 Using Device Explorer To Configure the Receiver	60	9.2 Fine Tuning	80
8.7.1 Support of remote commands for EX Bus devices	63	9.2.1 Flight Modes	80

9.2.2 Digital trim	83	9.3.5 Sounds on Event (Sound Assignments)	109
9.2.3 Flight Mode Trims	85	9.3.6 Sequencer	110
9.2.4 Dual Rate/Exponential	86	9.3.7 Accelerometer (DS only)	111
9.2.5 Programmable Function Curves	88	9.3.8 Telemetry Controls	112
9.2.6 Aileron Differential	90	9.3.9 Sound of Proportional Controls	113
9.2.7 Ailevator Function	90	9.4 Timers/Sensors	115
9.2.8 V-Tail Mix	91	9.4.1 Timer	115
9.2.9 Delta/Elevon Mix	92	9.4.2 Alarms	117
9.2.10 Butterfly Mix	92	9.4.3 Vario	118
9.2.11 Free Mixes	94	9.4.4 Voice Output	119
9.2.12 Governor/Gyro	97	9.4.5 Sensors/Logging Setup	120
9.2.13 Throttle Limiter	98	9.4.6 Displayed Telemetry	121
9.2.14 Snap Roll	98	9.4.7 Main Screen	124
9.3 Advanced Properties	100	9.5 Applications	125
9.3.1 Other Model Options	100	9.5.1 Data Analyzer	125
9.3.2 Sticks / Switches Setup	101	9.5.2 Audio Player	126
9.3.3 Wireless Modes/Trainer	102	9.5.3 JETIBOX	126
9.3.4 Logical Switches	107	9.5.4 Games	127

9.6 System	127	10.2 Update Firmware	140
9.6.1 Configuration	127	10.3 Sounds, Alarms & Acoustic Updates	140
9.6.2 Servo & Range Test	129	10.4 System Backup	141
9.6.3 View Inputs	130	10.5 PC Joystick	141
9.6.4 Receiver Output (Servo Monitor)	131	10.6 Telemetry Data Logging	141
9.6.5 System sound	131	10.7 Copying models between the transmitters	141
9.6.6 Sound Volume	132		
9.6.7 Installed Modules	132	11. Battery Safety Handling Rules	142
9.6.8 Limitations in copying models between transmitters	133	11.1 Transmitter Battery Pack	142
9.6.9 USB	133	11.2 General Safety Rules	142
9.6.10 Info	133	11.3 Flight Safety Check	143
9.7 Throttle Lock	135	11.4 Application	143
9.8 Select Input control	135	11.5 FCC/IC Information	143
9.9 Trim Menu	139		
9.10 How Transmitter Output Functions are Processed	139	12. Model Menu – Airplane/Sailplane	145
		12.1 Butterfly Mix (Crow Mix)	145
10. Transmitter to PC Connection	140	12.2 Aileron Differential	145
10.1 Memory & System Files	140	12.3 Ailevator	146

12.4 V-Tail Mix 146

12.5 Delta/Elevon Mix 147

12.6 Spoilers to Elevator Mix 147

12.7 Ailerons to Rudder Mix 148

12.8 Rudder to Ailerons Mix 149

12.9 Butterfly (Crow) Mix 150

12.10 Rudder to Elevator Mix 151

12.11 Aileron to Flap Mix 152

12.12 Aileron to Flap Mix (Brake Variation) 153

12.13 Elevator to Flap Mix 153

12.14 Flaps Mix – Camber Control 154

12.15 Throttle Cut (Kill Switch) 155

12.16 Throttle Idle 155

13. Accessories for Transmitters 156

13.1 Tray for DC-16 156

13.2 Stick Ends for DC/DS 156

13.3 Replacement switches 156

13.4 Straps for DC/DS 157

13.5 Charging 157

13.6 Other 157

13.7 Overview of the DS-14 expansion modules
(transmitter equipment comparison)..... 158

1 Introduction

1.1 DC/DS

The DC/DS transmitters were developed and produced with the cooperation of professional and world champion pilots. These transmitters were created with the goals of maximum utility, simple handling, maximum durability and the ultimate reliability of their mechanical parts. The metal case, with its chemically resistant outside surface treatment, provides maximum protection for the interior components. The straightforward case shape makes servicing easy. The metal, quad ball bearing equipped, stick gimbals with their magnetic Hall sensors are another revolutionary design concept used to make the DC/DS among the world's most advanced R/C systems.

Purposefully placed at the top of the transmitter, the 3.8" backlit LCD display with its wide viewing angle offers nearly perfect visibility in just about any lighting condition. Thanks to its high resolution display and use of a relatively large number of graphic images it was possible to create a simple and intuitive setup procedure for displaying telemetric data.

The DUPLEX EX family of products have been equipped with an improved telemetric data transfer system which can be viewed on the LCD transmitter display or saved for later analysis on a PC. The transmitter allows the setup of audible notifications (optionally created by the user), which can be related to actual telemetric values or to sound alarms or signals which have been assigned to conditions of various control elements.

1.2 DS-14

The DS-14 hand-held transmitter expands the range of model transmitters equipped with the JETI Duplex system, this new design is based on the high-end model DS-16. Unlike the DS-16, the DS-14 offers a unique concept of individual feature setup based upon the requirements of each customer. The transmitter is available in a basic configuration that will meet the needs of most users for most model types. For individual setting of the transmitter there is a configurator available at swshop.jetimodel.com. After the simple registration of your transmitter it is possible to select additional features based upon your individual demands. For example, if you fly only helicopter models, select such features as "**Throttle Limiter**" or "**Gyro Settings**" but you will probably not need to increase the number of flight modes. These are more suitable for controlling glider models.

The DS-14 features newly designed gimbal sticks. We managed to keep all the characteristics of the full metal sticks used in the DS-16, mainly thanks to high-quality materials and Hall sensors inside the sticks which are fully supported by high quality ball bearings.

As a result, the DS-14 becomes a powerful tool with the possibility to individually select many features at a very attractive price.

1.2.1 Activation method for software modules of JETI model

1. Make sure you have the most current firmware version in your transmitter.
2. Register on swshop.jetimodel.com.

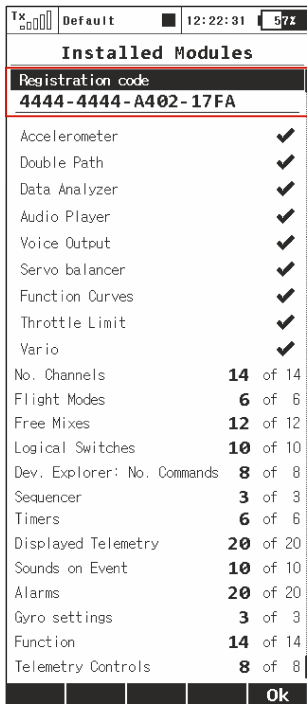

3. After clicking on the „Register new product“ button you will be redirected to a form where you enter a product type (DS-14), followed by the „serial number“ (SN:xxxxxxxx) (to be found on the back of the transmitter behind the screen) and then enter the „16 digit registration code“ (xxxx-xxxx-xxxx-xxxx) (see the menu „System -> Installed Modules“ highlighted by the frame). After registering your transmitter, you can select individual function modules that you want to activate.

4. Mark selected modules and proceed to checkout.

5. Then you will be asked to pay the relevant amount. After payment, a unique nontransferable file named „Activation.bin“ will be

generated. It will then be sent to your e-mail.

6. Connect the DS-14 to your computer and enable USB mode.
7. Copy the „Activation.bin“ file to the transmitter SD card into the root folder. The contents of the transmitter SD card can then look like this:

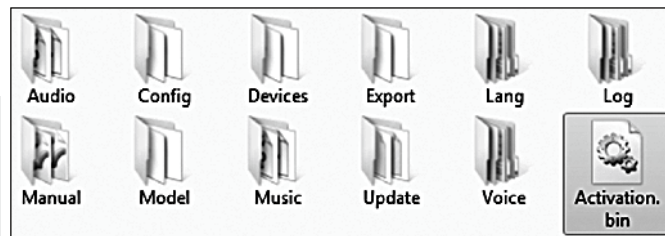

8. Disconnect the transmitter from the computer (Do not forget to confirm the safe hardware removal). Then confirm in your transmitter that you want to update and restart it.

If the activation is successful, an informative table with a list of modules appears immediately after switching on. Then it is possible to operate the transmitter as usual.

1.3 Features

Duplex 2.4GHz – the DC/DS transmitters feature the Duplex 2.4GHz, frequency hopping, digital, data stream system originally developed by JETI model in the Czech Republic. This system has been reliably used for many years.

Built-in Telemetry – from the start, the DC/DS transmitters were designed and built with many attractive features and include the full integration of all Duplex telemetry sensors.

Transmitters - these designs emphasize use comfort, state-of-the-art appearance and use premium quality materials.

Precise Gimbals – the transmitter gimbals are equipped with Hall sensors and ball bearings for precision movement with an almost unlimited lifespan.

LCD Display – oversized 3.8" backlit LCD display with 320x240 resolution which is highly visible under any light conditions.

Li-Ion Battery – provides a proven and reliable energy source with a high capacity (3200mAh) and a long service life.

Easy Charging – simply connect the wall power supply to the transmitter. The DC/DS may also be charged through their USB to PC interface. The charging progress is shown on the DC/DS display.

Integrated Antenna – the antennas are located behind fully integrated covers in both the DC-16 and DS-14/16 cases for protection against mechanical damage.

Large Memory – 4GB memory space for storing models, sounds, and telemetry data.

USB Connector – convenient connection to your PC. Fast firmware & sound upgrades, telemetry data downloads.

Fast Navigation – 3D wheel-style interface combined with function keys allow for speedy navigation within the DC/DS menu.

Digital Trims – fully programmable trims and a revolutionary automatic trimming function.

Swappable and Assignable Switches – all of the switches on the DC/DS transmitters (2- or 3-position) can be easily moved and assigned to create a custom configuration that works best for your application.

Programming – the logical and intuitive transmitter firmware is designed to be simple to use. Just follow the step-by-step screens. The creation of a new model can be accomplished with just a few easy steps.

Sounds/Alarms – the DC/DS transmitters are equipped with audible alarms and also allows the use of user-recordable alarms and sounds to keep you fully informed while also keeping distractions to a minimum."

Depends on equipment - The specific function is available if the corresponding module is activated. The DC-16 and DS-16 transmitters in their basic version have all the modules activated on maximum possible values. With the DS-14 transmitter it is possible to take advantage of the system that enables purchasing of the

extended functions from swshop.jetimodel.com.



1.4 Table of Contents

To make navigation faster, the DC/DS transmitter Instruction Manual has been divided into 5 basic groups:

1. Introduction and product support.
2. Basic description and mechanical adjustments.
3. First time switch-on. Basic helicopter and airplane set up.
4. Advanced programming. Detailed descriptions.
5. PC upgrade/upload, safety information, and special mixes.

Important parts of the instructions are separated from the text and highlighted according to importance.

Advice

Note

Warning

Advanced modelers may want to begin with group 3 where you will get all of the basic information for model setup. This is the quickest way to understand the basic ideas of the DC/DS transmitter programming and with this basic information you can begin to create your own model. More advanced programming functions are found in group 4. This is where you can find detailed descriptions of all of the DC/DS functions. The last section provides detailed description of firmware upgrades, downloads, and special mixes.

1.5 Technical Support

If you feel uncertain about how to set up particular transmitter functions, do not hesitate to take advantage of our technical support:

1. Web Site

Either the JETI model (manufacturer) or your local distributor's web sites offer a wide range of support for the DC/DS transmitters. You will find advice, tips or frequently asked questions (FAQ) which, in most cases, contain the answers to your questions.

2. Distributor, Manufacturer

You may also find support at your local hobby shop, distributor, or directly with the manufacturer JETI models.r.o.

3. Service and Warranty Coverage

JETI model CZ exclusively warrants that the products purchased will be free from defects in materials and workmanship for a period of 24 months from the date of purchase by the customer. This warranty covers only those products purchased from an authorized JETI model CZ distributor or dealer. Third party transactions are not covered by this warranty. Proof of purchase is required for warranty claims. Repair or replacement decisions are at the sole discretion of JETI model CZ or an authorized service provider. This warranty does not cover cosmetic damage or damage due to an accident, misuse, abuse, negligence, commercial or research use, or modification of or to any part of the product. This warranty does not cover damage due to improper installation, operation, maintenance, or attempted repair by anyone other than JETI model CZ or an authorized service provider.

JETI model CZ reserves the right to change or modify this warranty without notice and disclaims all other warranties, expressed or implied.

1.6 DC-16 Package Contents

1. JETI DC-16 Transmitter
2. Wall Power Supply
3. JETI DC-16 Transmitter Aluminum Case
4. USB PC Cable
5. Installation Hex Key Set (1,5mm; 2mm)
6. Cleaning Cloth, Instruction Manuals



1.7 DS-16 Package Contents

1. JETI DS-16 Transmitter, **2.** Wall Power Supply, **3.** JETI DS-16 Transmitter Aluminum Case, **4.** USB PC Cable, **5.** Installation Hex Key Set (1,5mm;2mm), **6.** Cleaning Cloth, Instruction Manuals



1.8 DS-14 Package Contents

1. JETI DS-14 Transmitter, **2.** Wall Power Supply, **3.** USB PC Cable, **4.** Installation Hex Key Set (1,5mm;2mm), Instruction Manuals.



2 System Specifications

2.1 DC-16

Frequency	2.4GHz
Dimensions WxLxH (with Antenna)	180x270x40 mm 7.1x10.6x1.6", (230x270x40mm) (9.1x10.6x1.6")
Weight	1.5kg (53 oz)
Number of Channels	16
Number of control directions using all Sticks/Switches/Knobs	Up to 20
Resolution	4096 steps
Battery	Li-on 3200mAh 3.6V
Operating Time	Up to 11 hours
Internal Memory	microSD 4GB
Telemetry	Yes
PC Connection	USB mini
Graphic Display	3.8" - 320x240px
Operational Temperature	-10 up to 60 °C (14 up to 140°F)

2.2 DS-16

Frequency	2.4GHz
Dimensions WxLxH (with Display)	194x172x40 mm 7.7x6.8x1.6" (194x233x40 mm) (7.7x9.2x1.6")
Weight	1.25kg (44 oz)
Number of Channels	16
Number of control directions using all Sticks/Switches/Knobs	Up to 18
Resolution	4096 steps
Battery	Li-on 3200mAh 3.6V
Operating Time	Up to 11 hours
Internal Memory	microSD 4GB
Telemetry	Yes
PC Connection	USB mini
Graphic Display	3.8" - 320x240px
Operational Temperature	-10 up to 60 °C (14 up to 140°F)

2.3 DS-14

Frequency	2.4GHz
Dimensions WxLxH (with Display)	194x172x40 mm 7.7x6.8x1.6" (194x233x40 mm) (7.7x9.2x1.6")
Weight	1.25kg (44 oz)
Number of Channels	Up to 14
Number of control directions using all Sticks/Switches/Knobs	Up to 18
Resolution	4096 steps
Battery	Li-on 3200mAh 3.6V
Operating Time	Up to 11 hours
Internal Memory	microSD 4GB
Telemetry	Yes
PC Connection	USB mini
Graphic Display	3.8" - 320x240px
Operational Temperature	-10 up to 60 °C (14 up to 140°F)

Software modules	Basic	Extended
Number of channels	8	14
Accelerometer	○	●
Secondary transmitter module in Trainer/Student or „Double Path“ *) function	○	●
Number of flight modes	3	6
Free mixes	5	12
Telemetry analysis via graphs	○	●
Audio player	○	●
Logical switches	0	10
Number of control commands	0	8
Sequencer	0	3
Timers	3	6
Number of telemetry items on the LCD	10	20
Sounds on events	5	10
Alarms	10	20
Voice output	○	●
Gyro setting function	1	3
Servo balancer	○	●
Function curves	○	●
Telemetry controls	0	5
Throttle limiter	○	●
Vario	○	●

*) Double Path mode allows the operation of two separately paired receivers in a model. Even if this module is not activated, both transmitter modules communicate with the receiver for the best possible connection quality and safety.

- - The module is not included in the basic version
- - This function is available after purchasing the module

3 Description of Transmitter DC-16



3.1. Control Identification

1. Right Stick 1, 2 – the DC-16 Transmitter Supports Modes 1-4, see Control Sticks -> mode change
2. Left Stick 3, 4 the DC-16 Transmitter Supports Modes 1-4, see Control Sticks -> mode change
3. Swappable and Assignable Switches: Sa, Sb, Sc, Sd, Se, Sf, Sg, Sh, Si, Sj
4. Digital Trims for the Left Stick T3, T4
5. Digital Trims for the Right Stick T1, T2
6. Right Side Control Lever 5
7. Left Side Control Lever 6
8. Rotary Control Knob 7
9. Rotary Control Knob 8
10. LCD Display
11. Function Buttons F1 – F5
12. Transmitter On/Off Power Switch
13. 3D Control Selector
14. Menu Button
15. ESC Button
16. Antenna/Transmitter Handle
17. Charge Jack
18. USB PC Interface
19. Earphone Jack
20. ON/OFF & Charging LED Indicators
21. Speaker
22. Transmitter Neck Strap Bracket Installation Holes

3.2. Assembly Identification

- 23. Battery Connector
- 24. Transmitter Battery Pack
- 25. PPM Output Connector
- 26. Left Gimbal Assembly
- 27. Right Gimbal Assembly

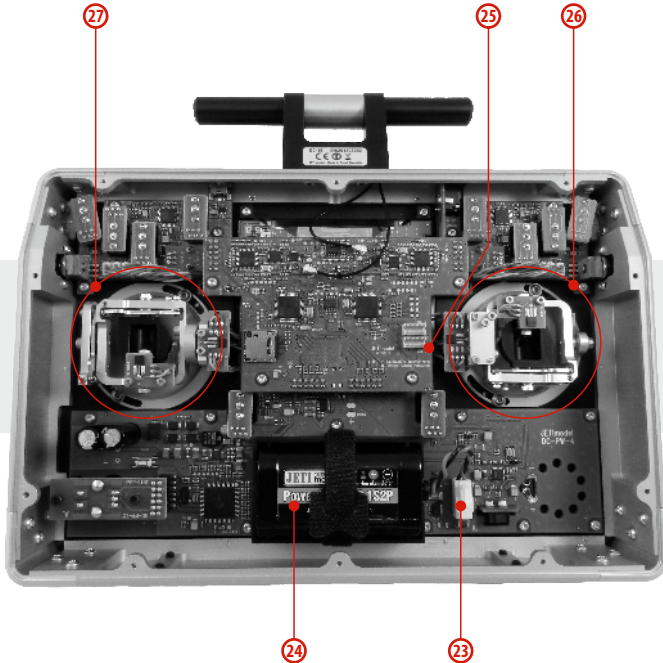

3.3 Control Stick Assembly

Note: When handling with back cover removed always switch off the transmitter and disconnect the battery (unplug the connector). Also do not connect the charging adapter or the USB cable.

Warning: Restrict your contact with the printed circuit boards to a minimum. You can damage your radio by electrostatic discharge!



3.3.1 Control Stick Length Adjustment

The stick length is adjustable to suit your flying style. The stick end separates into two parts.

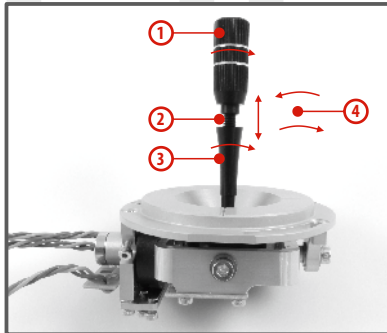

1. Hold the top part of the stick end firmly and unscrew (turn it counterclockwise).
2. Turn the stick end clockwise to shorten or counterclockwise to lengthen the overall stick length.
3. Adjust the lower part to support the top part of the stick end.
4. Finally secure by tightening both parts to each other.

Warning:

If you have installed optional sticks with switch or button ends, make sure that while adjusting the stick length you observe the wires that pass through the stick shaft and through the gimbal opening in order to prevent damaging the connecting cables. The safest method is to remove the small set-screw from the side of the stick housing to allow the switch or knob internals to remain stationary while you rotate the stick housing for height adjustment.. (See 4.3.6)

3.3.2 Swivel Control Stick Adjustment

In order to customize the feel of your radio you may adjust the angle of the stick control assemblies.

1. switch off the transmitter and remove the 10 screws that secure the radio back cover. Next, remove the radio back cover. **Be sure to disconnect the transmitter battery pack connector.**



- Loosen both machine screws securing the control stick assembly.

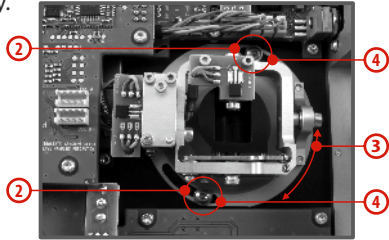

- Adjust (rotate) to desired position.
- Securely tighten both machine screws securing the control stick assembly.
- Reconnect transmitter battery pack and reinstall radio back cover and cover screws.

3.3.3 Control Stick Tension Adjustment

The stick gimbal tension is fully adjustable for each axis. This allows you to fully customize your radio's control feel. Simply adjust each gimbal's spring to your desired tension.

- Switch off the transmitter and remove the 10 screws that secure the radio back cover. Next, remove the radio back cover. **Be sure to disconnect the transmitter battery pack connector.**
- Use indicated machine adjustment screws to change the **desired spring** tension.
By turning the screw **anticlockwise, you will loosen** spring tension. As a result the moving resistance of the control stick will

decrease. By turning the screw **clockwise, you will tighten** spring tension. As a result the moving resistance of the control stick will **increase.**

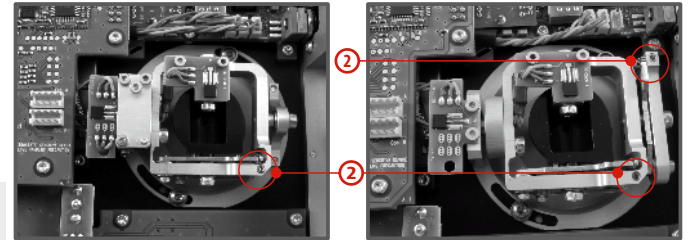

- Reconnect transmitter battery pack and reinstall radio back cover and cover screws.

3.3.4 Ratchet Tension Adjustment

Do you prefer smooth throttle feel or ratchet throttle feel? You can adjust the DC-16 transmitter either way you like allowing you to fully customize your radio's handling. Each tension is set by a different machine screw.

- Switch off the transmitter and remove the 10 screws that secure the radio back cover. Next, remove the radio back cover. **Be sure to disconnect the transmitter battery pack connector.**
- For ratchet tension adjustment use the machine screw "A". **Turn slowly (anticlockwise)** until you achieve the desired ratchet tension. For smooth tension adjustment, use the machine screw "B". **Turn slowly (clockwise)** until you achieve

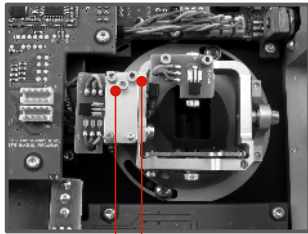

the desired smooth tension.



3. Reconnect transmitter battery pack and reinstall radio back cover and cover screws.

3.3.5 Throttle stick travel adjustment

The throttle stick travel is adjustable to suit your flying style.

1. Switch off the transmitter and remove the 8 screws that secure the radio back cover. Next, remove the radio back cover. Be sure to disconnect the transmitter battery pack connector.
2. Use indicated machine adjustment screws to limit the throttle stick travel. By turning the screw clockwise, you will shorten the throttle stick travel.
3. Reconnect transmitter battery pack and reinstall radio back cover and cover screws.

After making a limit the throttle stick travel you must re-calibrate the transmitter stick in the software menu, **see section 9.6.3 –Calibration of Proportional Controls.**

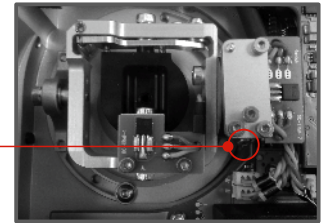
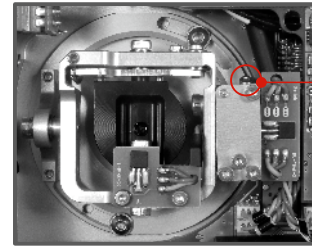

3.3.6 Transmitter Mode Switch

The DC-16 transmitter allows you to switch between Mode 1, 2, 3 and 4 stick configurations with just few simple steps. In order to do some of these, the stick control assemblies will need to be swapped.

1. Switch off the transmitter and remove the 10 screws that secure the radio back cover. Next, remove the radio back cover. **Be sure to disconnect the transmitter battery pack connector.**
2. Disconnect the control stick assembly wires from the Tx board. (3 wires X, Y, S)

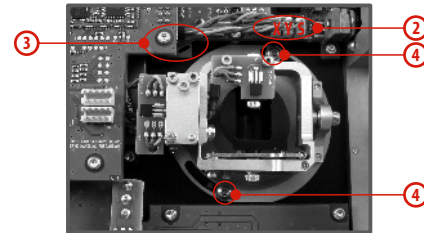

3. Remove the stick assembly connecting wires from their holders.

It may be necessary to remove the screws securing the RF circuit board to release the wire group.

- Remove both machine installation screws for each of the control stick assemblies.

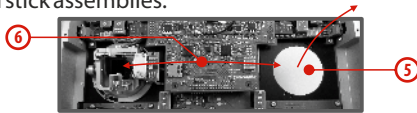

- Carefully remove both control stick assemblies. Gently pull in your direction (toward the transmitter back side).
- Swap both stick unit assemblies and install them back into correct positions.

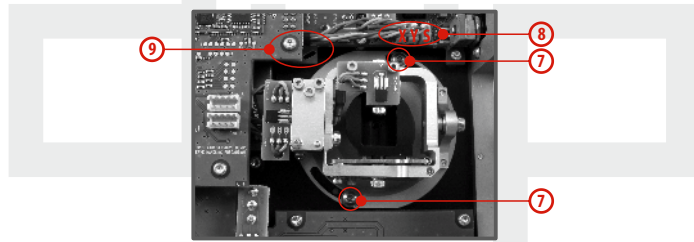

- Reinstall and secure the machine screws for each of the control stick assemblies.

Note: After making a mode switch you must re-calibrate the transmitter stick assemblies and setup the correct mode in the software menu, see section 9.6.1 – Configuration. The switch between Modes 1 to 3 or Modes 2 to 4 are done with the software only (NO manual stick change is necessary).

3.3.7 Transmitter Gimbals with Switch or Button Installation

If you want to operate the DC-16 transmitter using the optional stick end switch or button functions, you must purchase one or more of these separately:

- Stick with 2-position switch
- Stick with 3-position switch
- Stick with push-button
- Stick with potentiometer



Advice: For installation of the optional gimbal stick ends with switches/buttons we recommend that you send your transmitter to one of the factory authorized service centers or to your authorized dealer.

- Switch off the transmitter and remove the 10 screws that secure the radio back cover. Next, remove the radio back cover. **Be sure to disconnect the transmitter battery pack connector.**

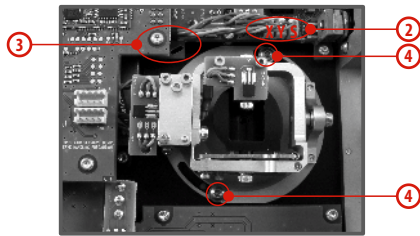

2. Disconnect the control stick assembly wires from the Tx board. (3 wires **X, Y, S**)
3. Remove the stick assembly connecting wires from their holders.
4. Remove both machine installation screws for each of the control stick assemblies.
5. Carefully remove both control stick assemblies. Gently pull in your direction (toward the transmitter back side). This upgrade will be done outside of the transmitter case.

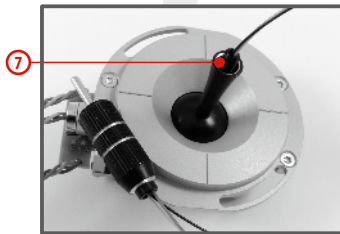
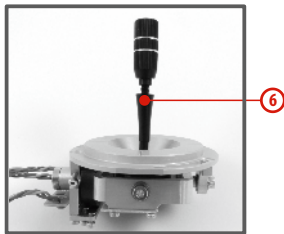

6. Unscrew the upper part of the stick assembly (anticlockwise).
7. Insert the connecting wires through the hollow opening of the transmitter stick.

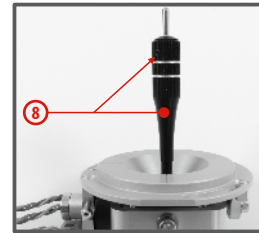

8. Adjust length of the stick to suit your flying style. (See 4.3)

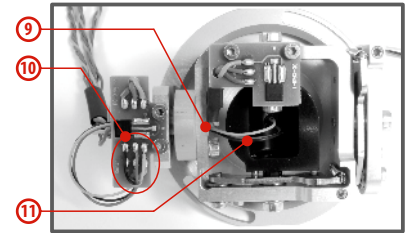

Note: After installation of the optional stick ends with switch or button make sure that while adjusting the stick length you observe the wires that pass through the stick shaft and through the gimbal opening in order to prevent damaging the connecting cables. The safest method is to remove the small set-screw from the side of the stick housing to allow the switch or knob internals to remain stationary while you rotate the stick housing for height adjustment.

9. Pass the switch wires through the same gimbal opening as the hall sensor cable (through the center of the gimbal assembly).
10. Next insert wire ends through the opening of the printed circuit board and solder them to the matching soldering points in such a way that the same color wires lay on the top of each other.
11. Carefully move transmitter sticks to their full outside positions in order to make sure that you have sufficient wire length and, if needed, adjust accordingly. The connecting cables for all moving parts of the unit should have sufficient length in order not to be exposed to any mechanical damage and any bending stresses.

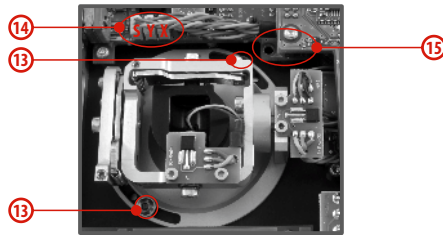

12. Install stick unit assembly back to correct position.
13. Install and secure the machine screws for the control stick assembly.
14. Connect control stick assembly wires to the Tx board connector (3 wires **X, Y, S**). Pay close attention to the wire lengths. Connect the longest wire as the first one from the outside of the transmitter (3 connectors **X, Y, S**).
15. Secure the stick assembly wires into their holders.
16. Reconnect transmitter battery pack and reinstall radio back cover and cover screws.

Installation and Configuration of Gimbals Switches

After the switch has been installed into the stick assembly you have to re-configure and enable it in the transmitter software before it will function properly. This can be done in the transmitter menu „**Main menu->Advanced setup->Sticks/ switches setup**“; see section 9.3.2.

3.4 Swappable and Assignable Switches

One of the most important features of a JETI transmitter is the switch function assignment flexibility. The DC-16 transmitter automatically detects the type of switch and assigns the selected function. The following switch types are available:

- 2-position short or long switch
- 2-position spring-loaded long switch
- 3-position short or long switch

You may either swap the existing switches around or take advantage of the optional accessories and create your own custom configuration.

Factory Switch Configurations for the DC-16 Transmitter

Sa - 2- position spring-loaded long switch

Sb - 3- position short switch

Sc - 2- position short switch

Sd - 2- position long switch

Se - 3- position short switch

Sf - 3- position short switch

Sg - 3- position long switch

Sh - 2- position short switch

Si - 2- position short switch

Sj - 3- position long switch

Switch Exchange:

1. Switch off the transmitter and remove the 10 screws that secure the radio back cover. Next, remove the radio back cover. **Be sure to disconnect the transmitter battery pack connector.**
2. With the specialized wrench (not included) carefully loosen and remove the switch installation nut.
3. Carefully hold the switch by its printed circuit board assembly and slowly pull it out. Use this method to also remove and exchange all of the other switches. After re-assembling and turning on your transmitter the software will sound a warning reminding you that you have executed a change. Always re-inspect all assigned functions of the switches before attempting to fly.

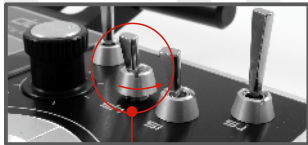

2

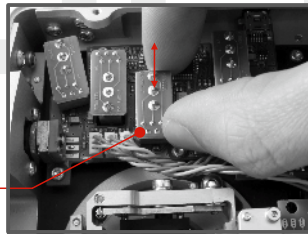

3

3.5 Digital Trims

Transmitter gimbals are used for controlling the basic flight functions like throttle, roll(aileron), pitch(elevator), and yaw(rudder). Immediately under the transmitter gimbal sticks you can see four push-buttons which are the programmable, digital trim buttons.



The digital trims are used for fine trimming of the flying model. When the transmitter is turned off, the trim values are stored in memory and are recalled when the system is turned back on.

Every model has its own trim setup. Also all flight modes may be configured to use different trim configurations. By pressing one of the buttons, the screen will automatically change to display the graphic position of that trim. The transmitter trims feature an acoustic step and centre beep alarm.

In the „Digital trim“ menu it's possible to enable a special function used as automatic trimming. Digital trim steps and trim range setting is explained in „Main menu->Fine tuning/flight modes->Digital trim“

3.6 Transmitter Battery Pack

The DC-16 transmitter is powered by a Li-Ion type battery pack and comes equipped with its own built-in advanced battery management and charging circuit. In switched-on position, the transmitter LCD display shows the status and condition of the battery pack. The Li-Ion battery is factory installed.

3.6.1 Charging

The DC-16 transmitter can be charged with the included wall power supply or through the built-in USB port.

For fast charging use the included wall power supply. Charging time is around 3 hours. During the charging process the transmitter can be in switched-on or off position. The charging status is clearly shown by lit red and green LEDs. If the transmitter is switched on during the charging process you can see the charging progress directly on the LCD display.

Transmitter Charging:

1. Plug in the included power supply to a wall outlet.
2. Plug the main charging connector into the transmitter. If the green LED goes out, the transmitter is not fully charged. The red LED indicates the battery charging status.
 - Discharged battery – red LED is slow blinking, the green LED is OFF
 - Close to full charge – red LED is permanently ON, the green LED is OFF
 - Fully charged battery – the red and green LEDs are ON

3.6.2 Battery Replacement

Should you decide to replace the transmitter battery, please follow these steps:

1. Switch off the transmitter and remove the 10 screws that secure the radio back cover. Next, remove the radio back cover.
2. Disconnect the transmitter battery connector.
3. Loosen the battery fastening strap and remove the battery.

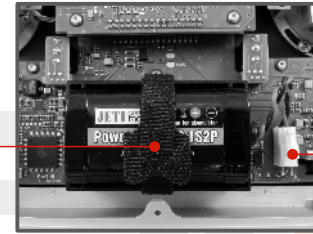

Note: If the transmitter battery has been disconnected for longer than 1 minute, the time, and date will be deleted.

Warning: DC-16 transmitters should only be operated only with original or manufacturer approved battery packs. The use of other battery packs will void the warranty.

3.7 PPM Input/Output Connector

The **PPM** output is accessible via connector labeled „B“. This connector features the non-stabilized battery voltage output in the range of 3.2V - 4.2V (max. 1A) which can be used as power supply for the connected HF module as well as for the PPM signal output. The transmitter output functions are in the form of a standard PPM signal.

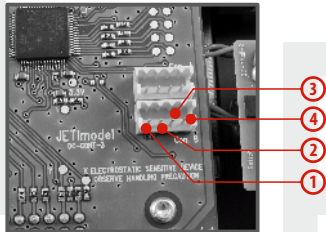

1. PPM input (3V logics)
2. Positive (+) pin
3. Negative (-) pin
4. PPM signal output (3V logics, configurable in „System -> Configuration“)

3.8 Handling

The DC-16 transmitter can be comfortably carried by holding it for the antenna cover/handle as shown on the picture.



Warning: Before each flying session, and especially with a new model, it's important to perform a range check. If you are operating a model with a DC-16 transmitter do not shield and avoid contact of the transmitter antenna with your body. This might increase likelihood of range problem.

4 Description of Transmitter DS



4.1 Control Identification DS-16

1. Right Stick 1, 2 – the DS-16 Transmitter Supports Modes 1-4, see Control Sticks -> mode change
2. Left Stick 3, 4 the DS-16 Transmitter Supports Modes 1-4, see Control Sticks -> mode change
3. Swappable and Assignable Switches: Sa, Sb, Sc, Sd, Se, Sf, Sg, Sh
4. Digital Trims for the Left Stick T3, T4
5. Digital Trims for the Right Stick T1, T2
6. Right Side Control Lever 5
7. Left Side Control Lever 6
8. Rotary Control Knob 7
9. Rotary Control Knob 8
10. LCD Display
11. Function Buttons F1 – F5
12. Transmitter On/Off Power Switch
13. 3D Control Selector
14. Menu Button
15. ESC Button
16. Shows the Antenna but NOT the handle.
Add the handle and assign it a number and pointer in the photo.
17. Charge Jack
18. USB PC Interface
19. Earphone Jack
20. ON/OFF & Charging LED Indicators
21. Speaker
22. Transmitter Neck Strap Bracket Installation Holes
23. Neckstrap Hook



4.2 Control Identification DS-14

1. Right Stick 1, 2 – the DS-14 Transmitter Supports Modes 1-4, see Control Sticks -> mode change
2. Left Stick 3, 4 the DS-14 Transmitter Supports Modes 1-4, see Control Sticks -> mode change
3. Swappable and Assignable Switches: Sa, Sb, Sc, Sf, Sg, Sh
4. Digital Trims for the Left Stick T3, T4
5. Digital Trims for the Right Stick T1, T2
6. Right Side Control Lever 5
7. Left Side Control Lever 6
8. Rotary Control Knob 7
9. Rotary Control Knob 8
10. LCD Display
11. Function Buttons F1 – F5
12. Transmitter On/Off Power Switch
13. 3D Control Selector
14. Menu Button
15. ESC Button
16. Shows the Antenna but NOT the handle.
Add the handle and assign it a number and pointer in the photo.
17. Charge Jack
18. USB PC Interface
19. Earphone Jack
20. ON/OFF & Charging LED Indicators
21. Speaker
22. Transmitter Neck Strap Bracket Installation Holes
23. Neckstrap Hook

4.3 Assembly Identification

- 23. Battery Connector
- 24. Transmitter Battery Pack
- 25. PPM Output Connector
- 26. Left Gimbal Assembly
- 27. Right Gimbal Assembly

DS-16

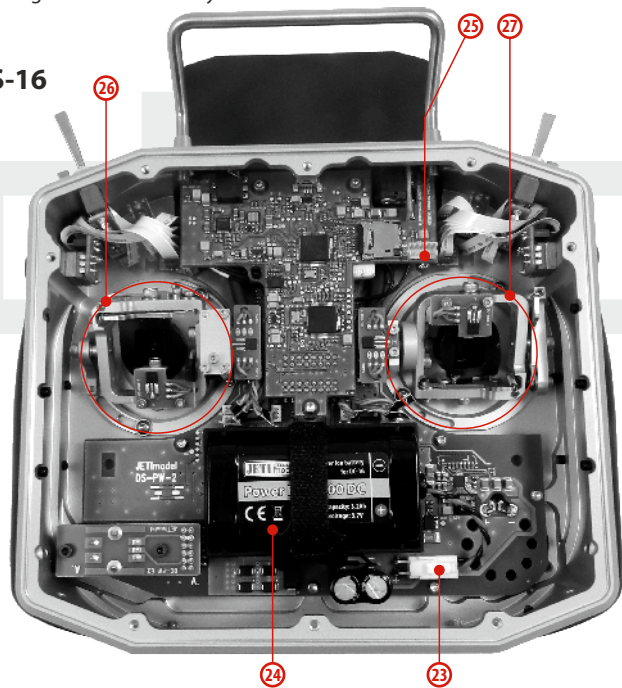

DS-14

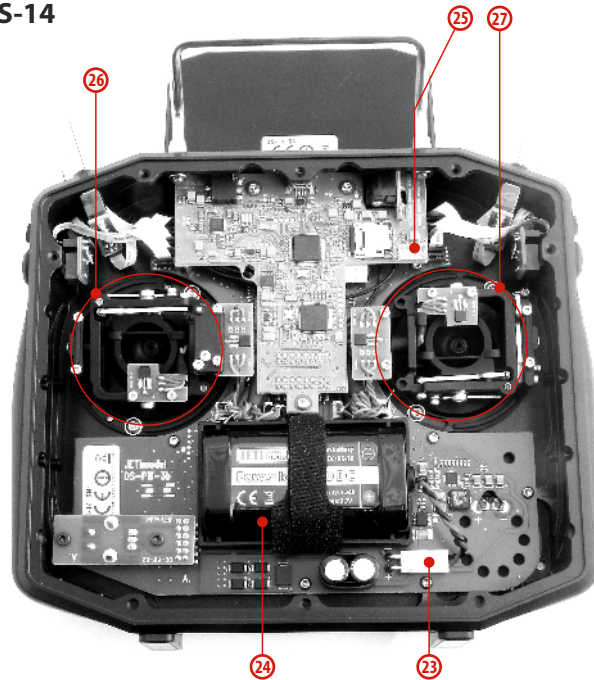

4.4 Control Stick Assembly

Note: When handling with back cover removed always switch off the transmitter and disconnect the battery (unplug the connector). Also do not connect the charging adapter or the USB cable.

Warning: Restrict your contact with the printed circuit boards to a minimum. You can damage your radio by electrostatic discharge!



4.4.1 Control Stick Length Adjustment

The stick length is adjustable to suit your flying style. The stick end separates into two parts.

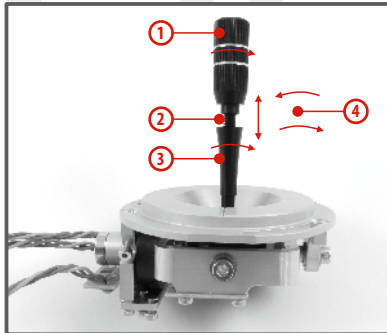

1. Hold the top part of the stick end firmly and unscrew (turn it anticlockwise).
2. Turn the stick end clockwise to shorten or counterclockwise to lengthen the overall stick length.
3. Adjust the lower part to support the top part of the stick end.
4. Finally secure by tightening both parts to each other.

Warning: If you have installed optional sticks with switch or button ends; make sure that while adjusting the stick length you observe the wires that pass through the stick shaft and through the gimbal opening in order to prevent damaging the connecting cables. The safest method is to remove the small set-screw from the side of the stick housing to allow the switch or knob internals to remain stationary while you rotate the stick housing for height adjustment.. (See 4.3.6)

4.4.2 Swivel Control Stick Adjustment

In order to customize the feel of your radio you may adjust the angle of the stick control assemblies.

1. Switch off the transmitter and remove the 8 screws that secure the radio back cover. Next, remove the radio back cover. **Be sure to disconnect the transmitter battery pack connector.**

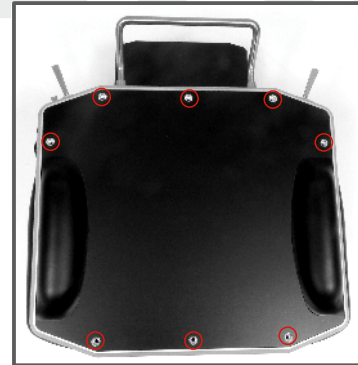

- Loosen both machine screws securing the control stick assembly.

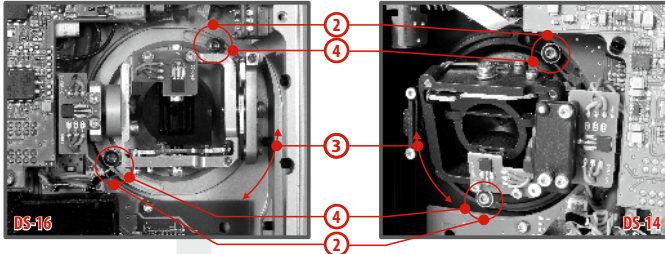

- Adjust (rotate) to desired position.
- Securely tighten both machine screws securing the control stick assembly.
- Reconnect transmitter battery pack and reinstall radio back cover and cover screws.

4.4.3 Control Stick Tension Adjustment

The stick gimbal tension is fully adjustable for each axis. This allows you to fully customize your radio's control feel. Simply adjust each gimbal's spring to your desired tension.

- Switch off the transmitter and remove the 8 screws that secure the radio back cover. Next, remove the radio back cover. **Be sure to disconnect the transmitter battery pack connector.**
- Use indicated machine adjustment screws to change the **desired spring** tension. By turning the screw **anticlockwise, you will loosen** spring tension. As a result the moving resistance of the control stick will

decrease. By turning the screw **clockwise, you will tighten** spring tension. As a result the moving resistance of the control stick will **increase.**

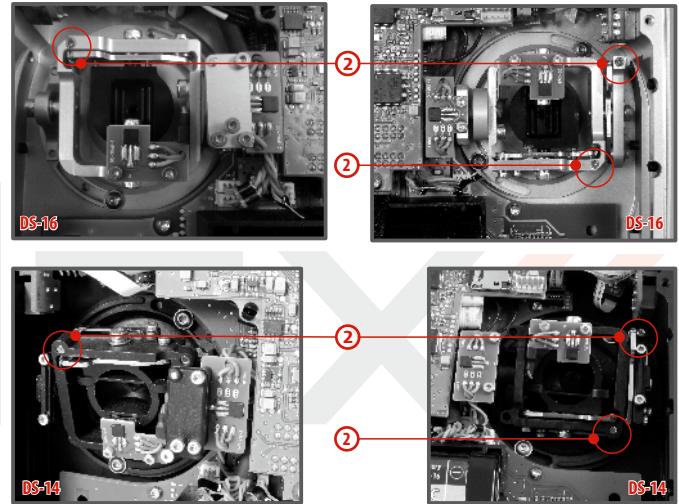

- Reconnect transmitter battery pack and reinstall radio back cover and cover screws.

4.4.4 Ratchet Tension Adjustment

Do you prefer smooth throttle feel or ratchet throttle feel? You can adjust the DS-16 transmitter either way you like allowing you to fully customize your radio's handling. Each tension is set by a different machine screw.

1. Switch off the transmitter and remove the 8 screws that secure the radio back cover. Next, remove the radio back cover. **Be sure to disconnect the transmitter battery pack connector.**
2. For ratchet tension adjustment use the machine screw "A". **Turn slowly (anticlockwise)** until you achieve the desired ratchet tension. For smooth tension adjustment, use the machine screw "B". **Turn slowly (clockwise)** until you achieve the desired smooth tension.

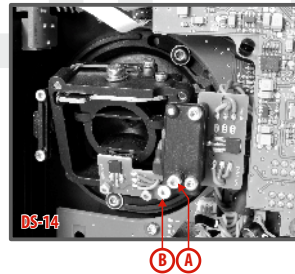
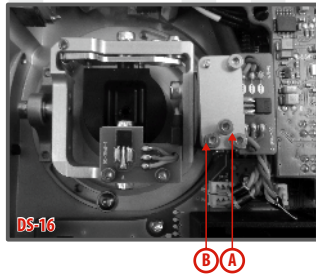

3. Reconnect transmitter battery pack and reinstall radio back cover and cover screws.

4.4.5 Throttle stick travel adjustment

The throttle stick travel is adjustable to suit your flying style.

1. Switch off the transmitter and remove the 8 screws that secure the radio back cover. Next, remove the radio back cover. Be sure to disconnect the transmitter battery pack connector.
2. Use indicated machine adjustment screws to limit the throttle stick travel. By turning the screw clockwise, you will shorten the throttle stick travel.
3. Reconnect transmitter battery pack and reinstall radio back cover and cover screws.

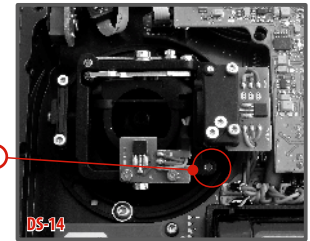
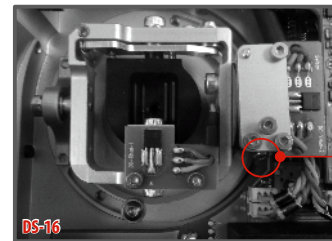
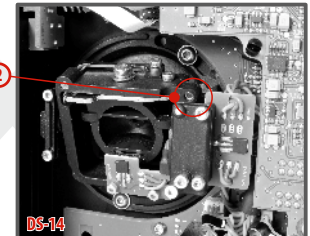
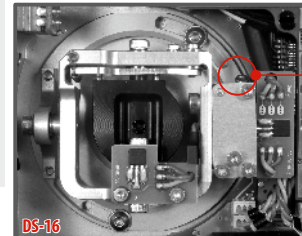

After making a limit change to the throttle stick travel you must recalibrate the transmitter stick in the software menu, **see section 9.6.3–Calibration of Proportional Controls.**

duplexX

4.4.6 Transmitter Mode Switch

The DS-16 transmitter allows you to switch between Mode 1, 2, 3 and 4 stick configurations with just few simple steps. In order to do some of these, the stick control assemblies will need to be swapped.

1. Switch off the transmitter and remove the screws that secure the radio back cover. Next, remove the radio back cover.

Be sure to disconnect the transmitter battery pack.

2. Release and pull out the screws of the upper printed circuit board (the "T" plate).
3. Remove the "T" circuit board by grasping the plate by its edges near where the bottom fastener goes. Gently lift the board to disconnect its connectors from the board below. Once disconnected, tilt the board upward toward the display so that it is out of the way.

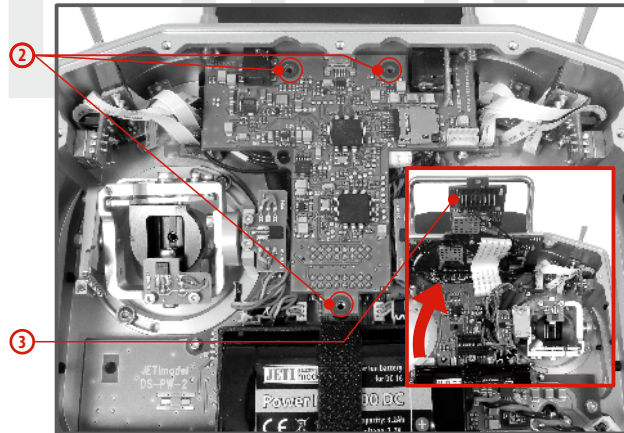

4. Disconnect the control stick assembly wires from the Tx board. (3 wires **X, Y, S**).
5. Remove the stick assembly connecting wires from their holders on the main board.
6. Remove both machine installation screws for each of the control stick assemblies.
7. Carefully remove both installation machine screws. Gently lift in your direction (toward the transmitter back side).
8. Swap both stick assembly units and install them back into their correct positions.

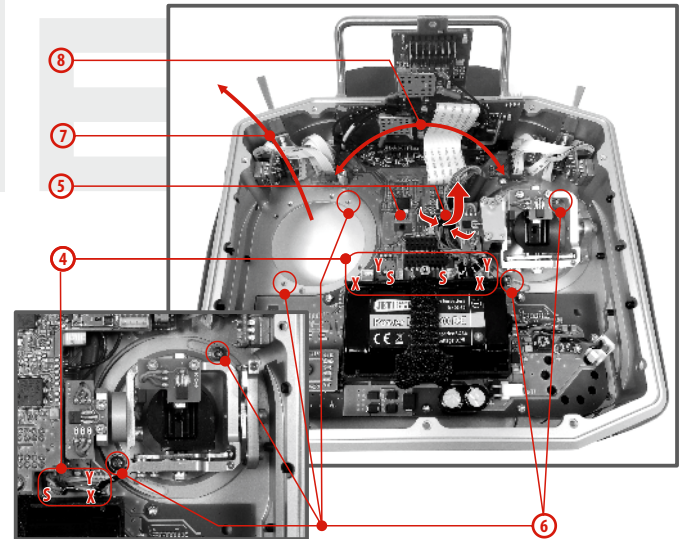

9. Reinstall and secure the machine screws for each of the control stick assemblies.
10. Connect the control stick assembly wires to the Tx board connector (3 wires **X, Y, S**). The orientation of the wires is labeled on the board.
11. Secure the stick assembly wires into their holders.
12. Mount the "T" plate back into place. First insert the connectors of the "T" printed circuit board into the body of transmitter and then carefully insert the "T" plate into its connectors on the main board. Be careful while handling the wires underneath the "T" plate to avoid any resistance when installing the "T" plate. If the wires cause any resistance or if the wires are pinched or stressed in any way, please re-route the wires and try the "T" board installation again.
13. Reinstall the "T" plate mounting screws.
14. Reconnect transmitter battery pack and reinstall radio back cover and cover screws.

Note: After making a mode switch you must re-calibrate the transmitter stick assemblies and setup the correct mode in the software menu, see section 9.6.1 – Configuration. The switch between Modes 1 to 3 or Modes 2 to 4 are done with the software only (NO manual stick change is necessary).

4.4.7 Transmitter Gimbals with Switch or Button Installation

If you want to operate the DS-16 transmitter using the optional stick end switch or button functions, you must purchase one or more of these separately:

- Stick with 2-position switch
- Stick with 3-position switch
- Stick with push-button
- Stick with potentiometer



Advice: For installation of the optional gimbal stick ends with switches/buttons we recommend that you send your transmitter to one of the factory authorized service centers or to your authorized dealer.

1. Switch off the transmitter and remove the 8 screws that secure the radio back cover. Next, remove the radio back cover. Be sure to disconnect the transmitter battery pack connector.
2. Release and pull out the screws of the upper printed circuit board (**the "T" plate**).
3. Remove the "T" circuit board by grasping the plate by its edges near where the bottom fastener goes. Gently lift the board to disconnect its connectors from the board below. Once disconnected, tilt the board upward toward the display so that it is out of the way.
4. Disconnect the control stick assembly wires from the Tx board. (3 wires **X, Y, S**).
5. Remove the stick assembly connecting wires from their holders on the main board.

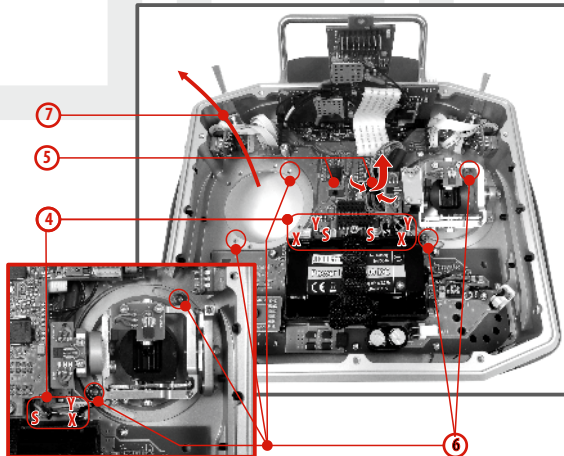
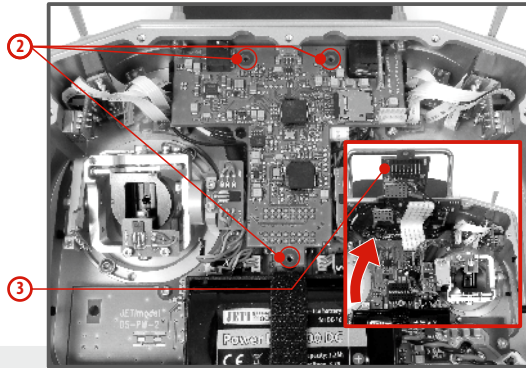

6. Remove both installation machine screws for each of the control stick assemblies.
7. Carefully remove both control stick assemblies. Gently lift in your direction (toward the transmitter back side).

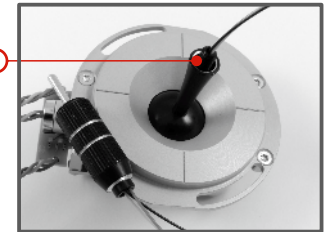
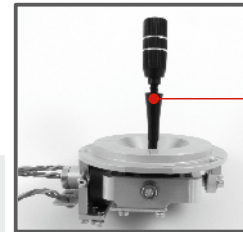

8. Unscrew the upper part of the stick assembly (anticlockwise).
9. Insert the connecting wires through the hollow opening of the transmitter stick.

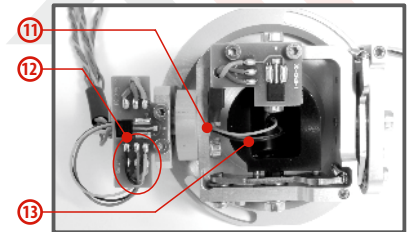
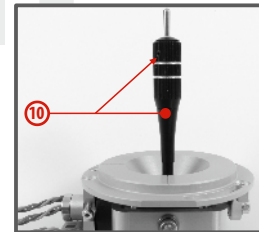

10. Adjust length of the stick to suit your flying style. (See 4.3)

Note: After installation of the optional stick ends with switch or button, make sure that while adjusting the stick length

you observe the wires that pass through the stick shaft and through the gimbal opening in order to prevent damaging the connecting cables. The safest method is to remove the small set-screw from the side of the stick housing to allow the switch or knob internals to remain stationary while you rotate the stick housing for height adjustment.

11. Pass the switch wires through the same gimbal opening as the hall sensor cable (through the center of the gimbal assembly).
12. Next insert wire ends through the opening of the printed circuit board and solder them to the matching soldering points in such a way that the same color wires lay on the top of each other.
13. Carefully move transmitter sticks to their full outside positions in order to make sure that you have sufficient wire length and, if needed, adjust accordingly. The connecting cables for all moving parts of the unit should have sufficient length in order not to be exposed to any mechanical damage and any bending stresses.
14. Install the stick unit assembly back into its correct position.
15. Install and secure the machine screws for the control stick assembly.

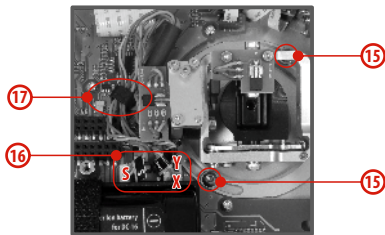

16. Connect the control stick assembly wires to the Tx board connector (3 wires **X, Y, S**). Pay close attention to the wire lengths. Connect the longest wire as the first one from the outside of the transmitter (3 connectors **X, Y, S**).
17. Secure the stick assembly wires into their holders.
18. Mount the "T" plate back into place. First insert the connectors of the "T" printed circuit board into the body of transmitter and then carefully insert the "T" plate into its connectors on the main board. Be careful while handling the wires underneath the "T" plate to avoid any resistance when installing the "T" plate. If the wires cause any resistance or if the wires are pinched or stressed in any way, please re-route the wires and try the "T" board installation again.
19. Reinstall the "T" plate mounting screws.
20. Reconnect transmitter battery pack and reinstall radio back cover and cover screws.

Installation and Configuration of Gimbals Switches

After the switch has been installed into the stick assembly you have to re-configure and enable it in the transmitter software before it will function properly. This can be done in the transmitter menu „**Main menu->Advanced setup->Sticks/ switches setup**“; see section 9.3.2.

Warning: You should keep the wire placement as shown in the picture. The wires must be placed as far as possible from the magnetic element **a)**. Please avoid permanent contact of the wire with the magnetic element. It could be damaged isolating of the wires.

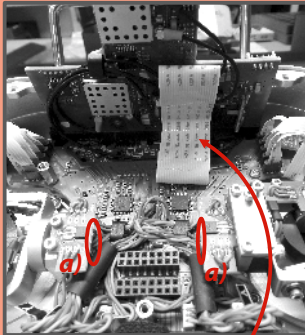

Proper arrangement of the display flat, flexible cable.

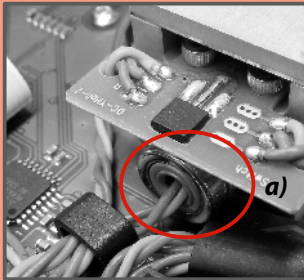
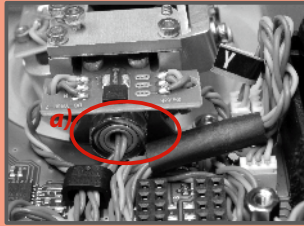
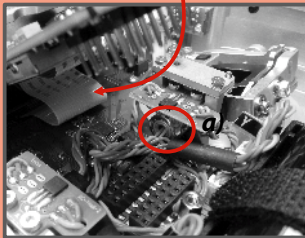

4.5 Swappable and Assignable Switches

One of the most important features of a JETI transmitter is the switch function assignment flexibility. The DS-16 transmitter automatically detects the type of switch and assigns the selected function. The following switch types are available:

- 2-position short or long switch
- 2-position spring-loaded long switch
- 3-position short or long switch
- 2-position locking switch
- potentiometer

You may either swap the existing switches around or take advantage of the optional accessories and create your own custom configuration.

Factory Switch Configuration for the DS-16 Transmitter

- Sa**-3- position short switch
- Sb**-2- position long switch
- Sc**-2- position short switch
- Sd**-2- position long switch
- Se**-3- position long switch
- Sf**-2- position short switch
- Sg**-2- position spring-loaded long switch
- Sh**-2- position short switch

Factory Switch Configuration for the DS-14 Transmitter

- Sa**-3- position short switch
- Sb**-3- position long switch
- Sc**-2- position short switch
- Sf**-3- position short switch
- Sg**-2- position spring-loaded long switch
- Sh**-2- position short switch

4.5.1 Switch Removal Procedure

1. Switch off the transmitter and remove the 8 screws that secure the radio back cover. Next, remove the radio back cover.
Be sure to disconnect the transmitter battery pack connector.
2. With the specialized wrench (not included) carefully loosen and remove the switch installation nut.

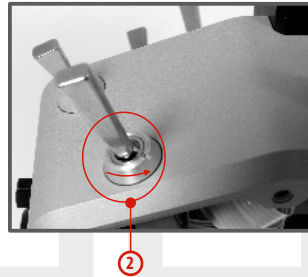
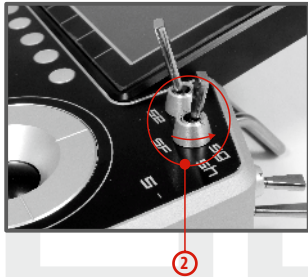

3. Hold the switch from the back side of the transmitter and pull it towards you, so that the switch is released from the body of transmitter.

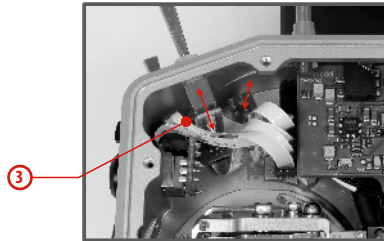

4. Disconnect the flat flexible cable from its connector on the main board.

The flat flexible cables that link the main printed circuit board with the switches are oriented as shown in the picture (4a). The wire is always color coded on one side of both ends (4b). The markings must be oriented as shown below.

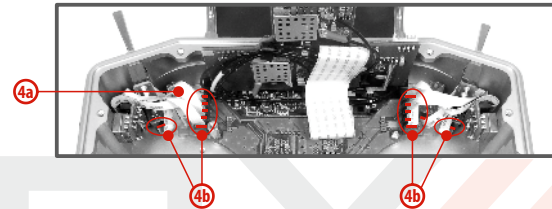

4.5.2 Assembly Procedure

1. Insert the flat flexible cable to the switch connector of the switch. See the orientation above.
2. Push the switch onto its spot in the transmitter housing.
3. Tighten the switch installation nut from the front of the transmitter. Use the specialized wrench (not included).
4. Connect the flat flexible cable to the main printed circuit board of the transmitter. See the orientation above.
The cable has to be inserted to the connector that matches the position on the front panel where the switch is installed.
5. Reconnect transmitter battery pack and reinstall radio back cover and cover screws.

After you turn on the transmitter for the first time after any switches have been modified, you will notice that the configuration for a selected model no longer matches.

Note: When replacing the switch **Sa** it is also necessary to remove the switches **Sb** and **Sc** from the transmitter body.

When replacing the switch **Sc** it is also necessary to remove the switch **Sb** from the transmitter body.

When replacing the switch **Sh** it is also necessary to remove the switches **Sg** and **Sf** from the transmitter body.

When replacing the switch **Sf** it is also necessary to remove the switch **Sg** from the transmitter body.

4.6 Digital Trims

Transmitter gimbals are used for controlling the basic flight functions like throttle, roll(aileron), pitch(elevator), and yaw(rudder). Immediately under the transmitter gimbal sticks you can see four push-buttons which are the programmable, digital trim buttons.



The digital trims are used for fine trimming of the flying model. When the transmitter is turned off, the trim values are stored in memory and are recalled when the system is turned back on.

Every model has its own trim setup. Also all flight modes may be configured to use different trim configurations. By pressing one of the buttons, the screen will automatically change to display the graphic position of that trim. The transmitter trims feature an acoustic step and centre beep alarm.

In the „Digital trim“ menu it’s possible to enable a special function used as automatic trimming. Digital trim steps and trim range setting is explained in „**Main menu->Fine tuning/flight modes->Digital trim“**

4.7 Transmitter Battery Pack

The DS-16 transmitter is powered by a Li-Ion type battery pack and comes equipped with its own built-in advanced battery management and charging circuit. In switched-on position, the transmitter LCD display shows the status and condition of the battery pack. The Li-Ion battery is factory installed.

4.7.1 Charging

The DS-16 transmitter can be charged with the included wall power supply or through the built-in USB port.

For fast charging use the included wall power supply. Charging time is around 3 hours. During the charging process the transmitter can be in switched-on or off position. The charging status is clearly shown by lit red and green LEDs. If the transmitter is switched on during the charging process you can see the charging progress directly on the LCD display.

Transmitter Charging:

1. Plug-in the included power supply to a wall outlet.
2. Plug the main charging connector into the transmitter. If the green LED goes out, the transmitter is not fully charged. The red LED indicates the battery charging status.
 - Discharged battery – red LED is slow blinking, the green LED is OFF
 - Close to full charge – red LED is permanently ON, the green LED is OFF
 - Fully charged battery – the red and green LEDs are ON

4.7.2 Battery Replacement

Should you decide to replace the transmitter battery, please follow these steps:

1. Switch off the transmitter and remove the 8 screws that secure the radio back cover. Next, remove the radio back cover.
2. Disconnect the transmitter battery connector.
3. Loosen the battery fastening strap and remove the battery.

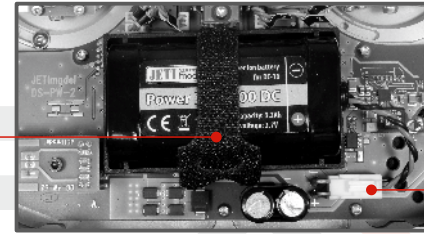

Note: If the transmitter battery has been disconnected for longer than 1 minute, the time and date will be deleted.

Warning: DS-16 transmitters should only be operated only with original or manufacturer approved battery packs. The use of other battery packs will void the warranty.

4.8 PPM Input/Output Connector

The **PPM** output is accessible via connector labeled „B“. This connector features the non-stabilized battery voltage output in the range of 3.2V - 4.2V (max. 1A) which can be used as power supply for the connected HF module as well as for the PPM signal output. The transmitter output functions are in the form of a standard PPM signal.

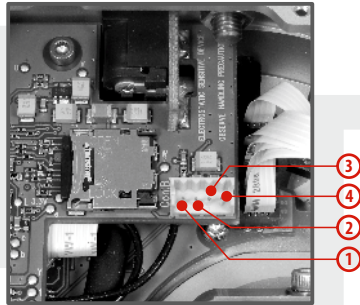

1. PPM input (3V logics)
2. Positive (+) pin
3. Negative (-) pin
4. PPM signal output (3V logics, configurable in „System->Configuration“)

4.9 Handling

The DS-16 is equipped with a metal handle for practical manipulation as shown in the picture.

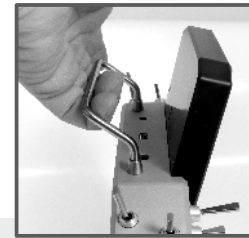

The transmitter antenna locations are shown in the picture below.



Warning: Before each flying session, and especially with a new model, it's important to perform a range check. If you are operating a model with a DS-16 transmitter do not shield and avoid contact of the transmitter antennas (see Photo) with your body.

5 RF Transmitter Modules

In order to achieve the highest transmission quality and reliability of the DC/DS transmitters, we have decided to equip the radio with two independent DUPLEX 2.4GHz transmitter modules. The transmitter modules have separate antennas. From the point of transmission they are fully independent from each other. The RF modules of the transmitter can operate in following modes:

- **„Default“mode** – the primary and secondary transmitter RF modules are active. Both modules alternately communicate with the receiver. This improves safety and helps to cover dead angles as well.
- **„Double Path“mode** – the transmitter RF modules communicate independently from each other with two different receivers. The receivers can be interconnected via an intelligent synthesizer, for instance the JETI Enlink, or the basic control functions can be divided between two independent receivers. In this mode one part of a model can be controlled with one receiver using the first transmitter RF module, the other part of a model with a second receiver and the second RF module. In an instant you have created a dual, redundant flying system with two receivers and two RF modules. This greatly improves safety and reliability since both RF modules alternate their communication with both receivers.
- **„Trainer“mode** – one of the RF transmitter modules is assigned to communicate with the instructor/student transmitter only. Communication with the model takes place via instructor's transmitter only. If the DC/DS transmitter is in

the „Instructor“ mode, the primary RF module communicates with the model and the secondary RF module communicates with the student's transmitter. In the „Student“ mode the DC/DS transmitter communicates via the primary RF module with the instructor's transmitter. If you operate two of the DC/DS transmitters, one of them in the „Instructor“ mode and the other one in the „Student“ mode, the transmitters communicate between each other via dedicated RF transmitter module. With this advanced system NO additional equipment is necessary.



6 Transmitter Powering ON/OFF

6.1 Transmitter Powering-ON

Switching-on is achieved by pressing and holding the „Power“ button (1). The green LED turns ON and the initial screen appears on the LCD display. At this point transmitter is waiting for final confirmation – press the **F5 (Yes)** button (2). After confirmation, the main screen is displayed and the transmitter is ready. The power-on status of the DC/DS transmitter is indicated by the lit green LED.

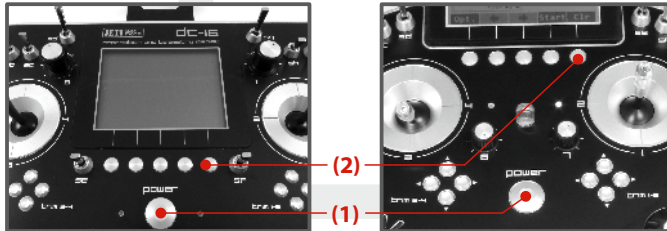

* If you do not confirm powering-on within a certain time limit, the transmitter will turn off automatically. In the DC/DS transmitter setup you may disable the confirmation by changing in the setup menu „Main menu->System->Configuration->Fast switch-on“.

Advice: We recommend that you leave the transmitter with the switch-on confirmation enabled, as this function prevents accidental turning-on and discharging of the transmitter battery.

6.2 Transmitter Turning-OFF

The transmitter is switched-off by pressing the „Power“ main button. Before complete power-down is achieved you will be asked for additional confirmation. In case of an emergency, a fast turn-off can be achieved by simultaneously pressing and holding the „Power“ and „esc“ buttons. **NEVER** use this alternative during normal working conditions.

Advice: If you want to find out the battery status on a switched-off transmitter just push the button „Power“ and the initial screen with the battery status will appear. If you do not confirm turning-on, the transmitter will shut down automatically. During the charging process this function is always activated.

6.3 Transmitter Restart

In case of erratic behavior we recommend that you restart the DC/DS to reboot the operation system.

1. Standard switch-OFF and ON with main „Power“ button.
 2. If necessary, use the Emergency Switch-OFF by simultaneously pressing and holding the „Power“ and „esc“ buttons.
 3. Disconnect and reconnect the transmitter battery connector.
- [a) Remove the screws that secure the radio back cover. Next, remove the radio back cover, b) Disconnect the transmitter battery connector, c) Press the „Power“ button to discharge the internal capacitors, d) Reconnect the transmitter battery, e) Reconnect transmitter battery pack and reinstall radio back cover and cover screws, f) Restart the system.]

7 Initial switching-on

Turn the transmitter on by pressing and holding the „Power“ button for a couple of seconds and then press the **"F5 (Yes)"** button to confirm, see chapter 6.1. The display shows the Main screen and displays the currently loaded model aircraft.

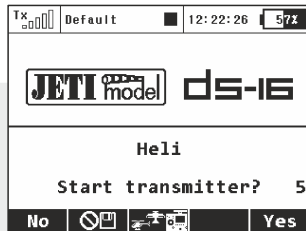

You can also immediately select a different model after the transmitter starts by pressing the **"F3"** button.

By pressing the **"F2"** button you are able to disable the logging feature for a current session. If you are just making adjustments to the model configuration, press the **"F2"** button and confirm. The logging will be disabled until restart of the transmitter.

To make the start-up screen visible, in the Configuration Menu, you have to select **"No"** for the **"Disable startup question"** option.

7.1 Main display

The main screen displays basic information about operation of your transmitter, such as the battery level, time, flight mode, etc. This screen will also display the user defined information you want to monitor, for example: **stopwatch, telemetry values, etc.** The main screen consists of three main sections: **the status bar, the desktop and the lower bar.**

The status bar at the top of the main display displays the following information:

1. Signal strength
2. Battery status
3. Time
4. Telemetry recording icon
5. Model Name
6. Name of actual flight mode

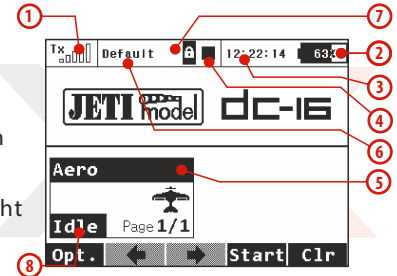

The Desktop is the largest part of the screen. This is where you can see your telemetry data and where any programmed alarms are displayed. The Desktop displays your user-defined information through the use of multiple pages. As you add or remove telemetry items or alarms, the number of available pages will automatically increase or decrease as needed.

In this example, the desktop page displays the following information:

7. ThrottleLock
8. Motor cut-off indication, idle

The lower bar is found at the bottom of the main display.

The lower bar shows:

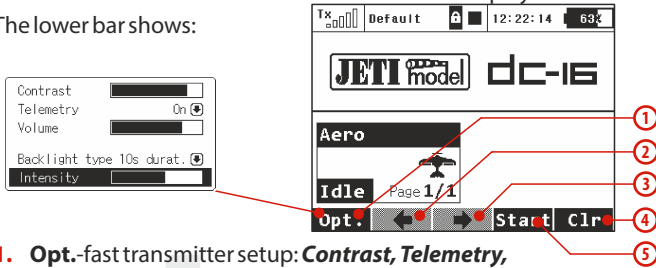

1. **Opt.**-fast transmitter setup: **Contrast, Telemetry, Volume, Duration of Backlighting, Backlighting Brightness.**
2. **Left Arrow**-move left within the desktop pages.
3. **Right Arrow**-move right within the desktop pages.
4. **Clr**-resets the timers or opens the Data Analyzer application in the main desktop window.
5. **Stop/Start**-begin and end flight timer, triggering timers or telemetry recording.

Use the corresponding **F1-F5** buttons to select these options

From the main display you may access the main menu by pressing the „**menu**“ button. To return from the main menu press either the „**menu**“ or „**esc**“ button.

From the main display, when you push any of the trim buttons or the **3D button** the „**Trim menu**“ will be displayed.

7.2 Navigation in the Menu

To navigate within the transmitter menus, use the following buttons:

1. The „**menu**“ button allows you to switch between the main display and the transmitter’s main menu.

Advice: Also, if you push this button while turning the 3D Control Selector to edit values, the values can be changed faster. With the menu button pressed, 10 more values are changed per turn.

2. The „**esc**“ button allows you to move one level back within the menu. If you push this button while you are editing a value you will return one menu level and the edited value will NOT be stored.
3. **3D Control Selector**
 - 3a - by turning the selector **anticlockwise you will move up in the menu.** Turning the selector this direction will also **decrease** any value you are editing.
 - 3b - by turning the selector **clockwise you will move down in the menu.** Turning the selector this direction will also **increase** any value you are editing.
 - 3c by **pressing** the selector you will confirm your choice/enter the selected menu.
4. The „**F1 - F5**“ functions buttons located below the display are used to select various options based upon the current display.

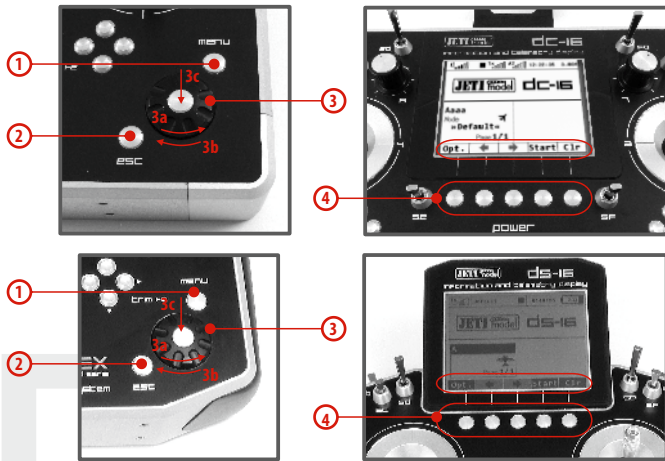

7.2.1 Browsing through the Menu

The current selection within the menu (cursor) is designated by reversed text/shaded graphics. By turning the 3D control selector left/right you will move through the lines of a menu.

To select an item, first highlight the line and then press the „3D button“, to select the line. Rotate the 3D control selector to highlight your selected item within the line, then press the „3D button“ to select the item. Rotate the 3D control selector either left or right to change the value of your chosen item. By pressing the „3D button“ again you will confirm the storage of your selected value and go back to your previously selected menu item. If you want to go back to select another line within the previous menu press the „esc“ button.

Note: For each press of the „esc“ button, you are taken back one menu level.

7.2.2 Basic Menu Structure

* Model

- Select Model
- New Model
- Basic Properties
- Functions Assignment
- Servo Assignment
- Servo Setup
- Device Explorer

* Fine Tuning

- Flight Modes
- Digital Trim
- Flight Mode Trim
- Dual Rate/Expo
- Function Curves
- Aileron Differential
- Gyro Settings (Heli)
- Throttle Limiter (Heli)
 - V-Tail, Delta Mix, Ailevator Mix (Aero)
- Butterfly (Aero)
- Snap Roll
- Free Mixes

* Advanced Properties

- Other Model Options
- Sticks/Switches Setup
- Wireless Modes/Trainer
- Logical Switches

- Sound on Event
- Sound of Prop. Controls
- Telemetry Controls
- Sequencer
- Accelerometer (DS-16 only)

* Timers/Sensors

- Timers
- Alarms
- Vario
- Voice Output
- Sensors/Logging Setup
- Displayed Telemetry
- Main Screen

* Applications

- Data Analyzer
- Audio Player
- JETIBOX
- Games (Snake, Tetris, Chess...)

* System

- Configuration
- Servo & Range Test
- View Inputs
- Receiver Output
- System Sound
- Sound Volume
- USB
- Info

***) The items displayed in the menu depend on the actual transmitter equipment and the model functions that are active.**

7.3 Model Set-up Guide

In this section we will guide you, step by step, through the process of creating a new model airplane and helicopter. Each step of the guide will be complete with associated transmitter menu photos. If you follow the step by step guide you should become familiar with how to create a model profile. You may even use these concepts and the „General“ model type to create your own, user-defined model profile.

7.3.1 Airplane

Let's create a simple model airplane. Our example will be a motor glider with ailerons controlled by two servos, an elevator and a rudder each controlled by one servo.

Servo assignment:

1. Throttle
2. Aileron 1
3. Aileron 2
4. Elevator
5. Rudder

Before you begin creating a model, make sure that you have set up the correct transmitter mode in „Main menu -> System -> Configuration -> MODE 1-4“. The basic, standardized, assignment of transmitter inputs to flight controls are based upon this selection.

First it is necessary to create a model in the transmitter and then bind the DC/DS transmitter with the receiver which will control the given model. **See chapter 8.3: „Receiver->Binding“.**

Warning: For safety reasons we recommend first removing the propeller.



1. Switch-on the transmitter. In the main display push the key „menu“. Select the item „Model“ and push the „3D button“.

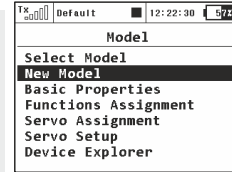

2. Select the item „New model“ and push the „3D button“.

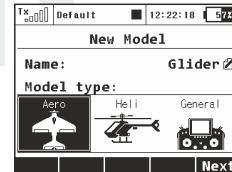

3. Enter the name of your model and press „F5(OK)“ (Note: you must enter a model name to proceed.) Then select the model type „AERO“. Confirm by pushing the „F5(Next)“ button.

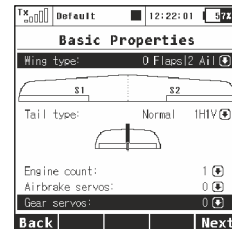

4. Select your wing type. Because this example has 2 aileron servos, select „Wing type“ **OFLP/2WING**. Do not change any other setup items like tail assembly, number of motors, number of spoilers or number of landing gear servos. Continue by pushing the „F5(Next)“ button.

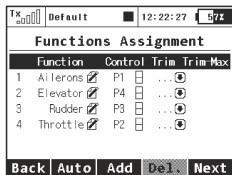

5. This page displays the flight control functions and their transmitter switch assignments. Here you can verify that your flight control functions are correctly assigned to the transmitter switches/sticks. If they are not, check and make sure that you have selected the proper transmitter mode. Confirm the assignments by pushing the „F5(Next)“ button.

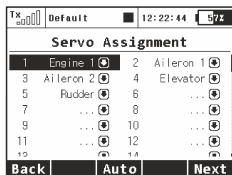

6. This page displays the assignment of functions to your receiver outputs (servos). You may change the assignments by editing the output assignment for each receiver channel. Otherways confirm with the „F5(Next)“ button.



7. The screen will now display a request which asks if you really want to create and activate the new model. Confirm with the „F5(Yes)“ button.



8. The Servo Setup menu is where you set the servo neutral positions, servo output travel limits, servo reversing, delay etc. You will come back to this menu after binding the receiver with your transmitter. Press the „F5(OK)“ button and you are taken to the main screen where your new model is displayed in a desktop page.

Bind transmitter with the receiver, **see chapter 8.4 Receiver->Binding.**

Once your transmitter has been bound with the receiver and you have re-applied power to the receiver, the last setup phase is the tuning of your servo output functions, **see chapter 7.3.4 Setup of receiver outputs.**

With this type of wing configuration there is usually a mixer used to also raise the ailerons as spoilers (spoilerons). Follow the steps below the set up this mixer. In this example we will use the „right side control lever(5)“ for the proportional control of the spoilerons.

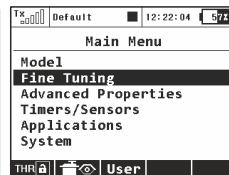

a. From the main screen, push the „menu“ button. Select „Fine tuning“ and push the „3D button“.

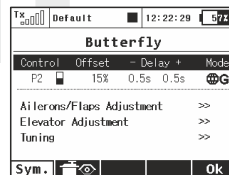

b. Next, select „Butterfly“ and push the „3D button“.

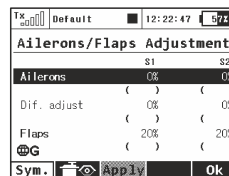

c. In the first menu line push the „3D button“, select „Switch“ and push the „3D button“ again. Next, move the „right side control lever(5)“. Confirm with the „F5(OK)“ button. The last step in this menu is to set the amount of travel that your ailerons will move as spoilerons (or flaperons) and to set any desired elevator compensation.

Note: When setting up your spoilers be sure that the ailerons still have enough travel to control your airplane when the spoilers are deployed. In this menu the „(Sym) F1“ button will link or unlink the spoilers if you need to set them independently

7.3.2 Helicopter

Let's create a simple model helicopter. In this example, the helicopter is controlled by a swash plate with three servos at 120° orientation and the motor has no governor.

Servo assignment for the receiver channels:

1. Throttle
2. Elevator (Swash 1F)
3. Collective (Swash 2L)
4. Aileron (Swash 3R)
5. Rudder (Yaw)
6. Gyro(Gyro sens.)

Before you begin creating a model, make sure that you have setup the correct transmitter mode in „Main menu -> System -> Configuration -> MODE 1-4“. The basic, standardized, assignment of transmitter inputs to flight controls are based upon this selection.

First it is necessary to create a model in the transmitter and then bind the DC/DS transmitter with the receiver which will control the given model. **See chapter 8.3: „Receiver->Binding“.**

Notice: For safety reasons we strongly recommend removing the main/tail blades or disconnecting the motor when working with an electric helicopter.



1. Switch on the transmitter. In the main display push the key „menu“. Select the item „Model“ and push the „3D button“.

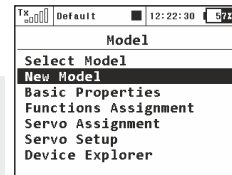

2. Select the item „New model“ and push the „3D button“.

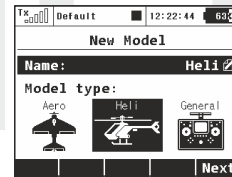

3. Enter the name of your model and press „F5(OK)“ (Note: you must enter a model name to proceed.) Then select the model type „Heli“. Confirm by pushing the „F5(Next)“ button.

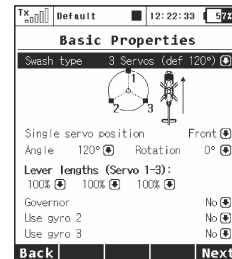

4. Select the helicopter swash plate type „3 servos (def 120°)“. Change the second menu item „Position of front servo“ to „Rear“ – the swash plate servo orientation will be turned 180°. Confirm the change by pressing the „F5(Next)“ button.

When you create a new helicopter model, you are required to define the swash plate configuration for the model. Please refer to your helicopter's instructions and verify that you have the correct swash plate configuration. If you find that you need to change your swash plate configuration, you can always go to the „**Model -> Basic Properties**“ menu to make the change.

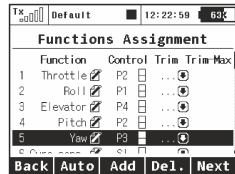

5. The „**Functions Assignment**“ menu lists the flight functions and their control switch/stick assignments. If you want to change any of the switch/stick assignments, select the „**Control**“ item for your flight function and then select your desired switch/stick for that flight function. Press „**F5(Next)**“ to confirm.

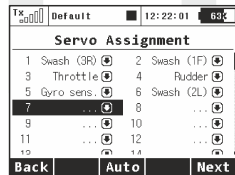

6. The „**Servo assignment**“ menu displays the receiver channels and their transmitter output assignments. If you want to change any of the output assignments, select the channel you want to edit and reassign its output. Otherways press „**F5(Next)**“ to confirm.

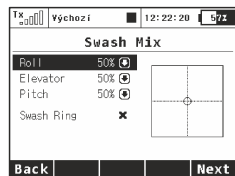

7. The „**Swash Mix**“ menu displays the travel range of each particular helicopter flight function for the swash plate. The travel range is displayed as a percentage. You can use these travel range adjustments to prevent linkage binding and to tune the helicopter to suit your flying style. You can

also activate a cyclic reduction of the rotor head travels (Swash Ring) so the servos cannot be damaged by large simultaneous movements of the sticks.(Refer to your helicopter's instruction manual.) Press the „**F5(Next)**“ button to confirm.

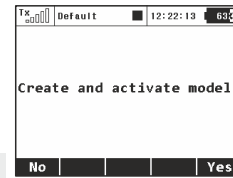

8. The screen will display a question which asks if you really want to create and activate the new model. Press the „**F5(Yes)**“ button to confirm.

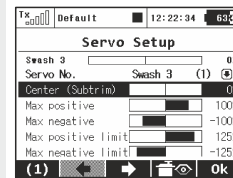

9. The „**Servo Setup**“ menu is where you can set all of your servo neutral positions, servo output throw limits, servo reversing, delay etc. You should return to this menu after you have bound your receiver and transmitter. **See chapter 8.4: Receiver->Binding.**

10. Once your transmitter has been bound with a receiver and has been connected to its power supply, the last step consists of tuning the servo output functions, **see chapter 7.3.4: Setup of receiver outputs.**

In the „**Fine tuning -> Flight modes**“ menu you will setup these advanced model control functions for your helicopter:

Collective pitch curve, see: **Fine tuning -> Flight Modes->Function Curves**

Throttle curve, see: **Fine tuning -> Flight Modes->Function Curves**

Dual rates, see: **Fine tuning -> Flight Modes -> Dual Rate/Expo**

Autorotation, see: **Fine tuning -> Flight Modes**

Gyro/Governor see: **Fine tuning -> flight modes -> Gyro/Governor**

For convenience, a quick link to all of these function settings has been made through the Heli Tuning menu.

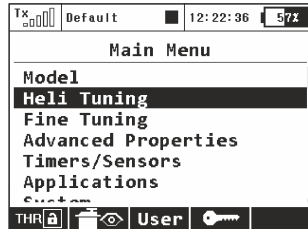

7.3.3 General

The DC/DS transmitter are not only equipped with the assistants for airplanes or helicopters, but they also have a „General“ assistant which can be used to create just about any other type of model. If your model cannot be assigned to the category of an airplane or helicopter, select the general model. The following setup describes the creation of a boat model. This process could also be used to create a profile for any other land/water/air model craft. In this example, the model is controlled by basic functions like throttle and rudder as well as by extended functions like a motor sound generator, lighting system, siren, and a smoke generator. The first three above mentioned functions are controlled proportionally and the rest are non proportional.

Servo assignment to receiver channels:

1. Motor
2. Rudder
3. Motor Sound Module
4. Lighting System
5. Siren Sound Module
6. Smoke Module

Before creating a model, make sure that you have setup the correct transmitter mode in „**Main menu -> System -> Configuration -> MODE 1-4**“. The basic, standardized, assignment of transmitter inputs to flight controls are based upon this selection.

First it is necessary to create a model in the transmitter and then bind the DC/DS transmitter with the receiver which will control the given model, **see chapter 8.3: „Receiver->Binding“**.



1. Switch-on the transmitter. In the main display push the key „**menu**“. Select the item „**Model**“ and push the „**3D button**“.

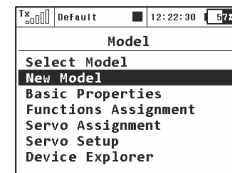

2. Select the item „**New model**“ and push the „**3D button**“.

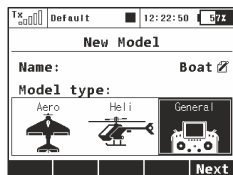

3. Enter the name of your model and press „F5(OK)“ (Note: you must enter a model name to proceed.) Then select the model type „General“. Confirm by pushing the „F5(Next)“ button.



4. The first item in the „Basic Properties“ menu is the number of motors in the model. In this example, this item will not be edited and we will proceed to the second item, which is how the motor needs to be controlled – i.e. whether the motor turns only one direction (Single) or both directions (Double). Edit the item „Motor type“ by selecting „Double direction“. Press the „F5(Next)“ button to confirm.

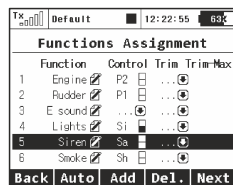

5. In the „Function Assignment“ menu use the „F3(Add)“ button to create all of your desired functions. Then you can assign transmitter control switches/sticks to the functions by editing each function’s „Control“ item, see chapter: „Select

control input“. The only exception is the motor sound module function, which you cannot simply assign to a control switch/stick, because it will be controlled by a mixer. The mixer will allow the motor sound will be played proportionally to the motor speed. For the siren function you may take advantage of the switch „Sa“

(spring-loaded switch). After you create all of your desired functions, press the „F5(Next)“ button to confirm.

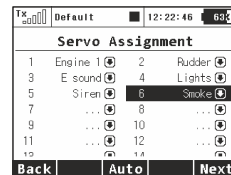

6. The „Servo assignment“ menu displays the receiver channels and their transmitter output assignments. The channels are assigned in the order that you created the functions in the previous menu. If you want to change any of the output assignments, select the channel you want to edit and reassign its output. Otherways press „F5(Next)“ to confirm.



7. The screen will display a question which asks if you really want to create and activate the new model. Press the „F5(Yes)“ button to confirm.



8. The „Servo Setup“ menu is where you can set all of your servo neutral positions, servo output throw limits, servo reversing, delay etc. You should return to this menu after you have bound your receiver and transmitter. **See the chapter 8.4: Receiver->Binding.**

Once your transmitter has been bound with a receiver and has been connected to its power supply, the last step consists of tuning the servo output functions, *see chapter 7.3.4: Setup of receiver outputs.*

To complete this model we just need to configure a free mixer from the throttle function to the motor sound module. In this example we will set a switch to enable/disable the mixer so that when the switch is „on“, the motor sound module is controlled with the throttle (motor speed). Go to the „*Fine tuning* -> *Free mixers*“ menu.

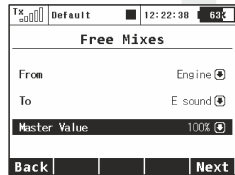

- a. Use the „F2(Add)“ button to create a new mixer. Select „Engine“ in the „From“ item. Then select „Sound M“ (the name of the sound function) in the „To“ item. The item „Master Value“ represents the amount of mixing from the input function

to the output function for this mixer. With the „F5(Next)“ button you will create the mixer and the display will change to show the overview of your programmed free mixers.

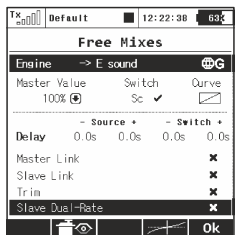

- b. To assign a switch for the activation and deactivation of the free mixer, press the „F4(Edit)“ button. Select and edit the „Switch“ item to assign a switch/stick to enable/disable the mixer.

7.3.4 setup of Receiver Outputs

Go to the „Model->Servo Setup“ menu. Use the „F2“ and „F3“ buttons to brows through the receiver outputs (channels).

You can scrol through the following servo adjustment items for each channel:

„Servoreversing“ – reverses the servo throw direction.

Move the stick for your selected channel and observe the direction of the servo movement. If the servo moves in the opposite of your desired direction, change the direction by editing the „Reverse“ item for that particular servo. Continue with each channel until all of the servos travel in the required directions.

„Center (Subtrim)“- adjusts the center position of each servo's output.

With your sticks in their neutral positions, scroll through each servo's page and use the „Center (Subtrim)“ item to correctly set all of your servo's center or neutral positions.

Note: You should mechanically adjust all of your servo arms and servo linkages to be as close to neutral or center as possible so that you will need as little subtrim as possible. Using large amounts of subtrim can limit the overall throw of your servo.

„**Max/Min.limit**“ – sets the absolute maximum servo output throw

Use these to limit the maximum range of servo throw in order to keep your servos from exceeding their mechanical limits or to keep your servos from binding when moving their arms or linkages to their full travel. You should use the dual rate function to set your model's useable control throws.

duplex

8 Receiver

8.1 Description

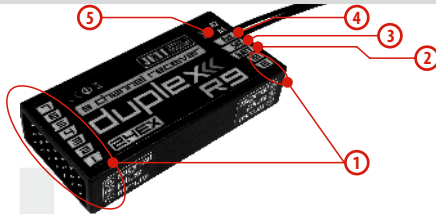

- 1.** JETI Duplex receivers use the universal or „JR Type“ servo connectors.
- 2. Bat** - receiver and servo power supply input. Whenever possible, always supply power to your receiver using more than one of these inputs. You can either supply power through the use of a Y-cable or through any unused receiver channel connection. To power the receiver you may use NiCd packs, the BEC from your ESC or Li-xx cells used with a voltage regulator, such as the JETI MAXBEC or similar.
- 3. SAT** - auxillary input/output for PPM signals. This input allows you to connect an additional JETI DUPLEX Rsat2 satellite receiver or an additional US version Duplex receiver. This allows you to increase the number of receiver antennas in your system for increased reliability in installations with shielded or badly oriented antennas.
- 4. EXT** - input for telemetry sensors. If you want to connect more than one telemetry sensor then use the JETI EXPANDER E4. You can „daisy-chain“ several of the E4 Expanders to support many, many sensors.

- 5. A1/A2** - receiver antennas. The antennas should be installed so that the wires form a 90° angle relative to each other.

8.2 Installation

Whenever possible, you should wrap the receiver in foam and place it as far as possible from sources of interference (servos, electric motors). Arrange the receiver antennas so that their active ends form a 90° angle and try to put them as far as possible away from each other. Take care not to bend them with a radius smaller than 1 cm. The active part of the antenna should not be placed close to metal parts. If your model has a carbon fuselage it is very important to place the active antenna ends outside the fuselage.

8.3 Binding

In order to achieve communication between transmitter and receiver you must bind them. During this process the transmitter learns the receiver address and will automatically find it again when switched back on. Communication begins with this receiver automatically if the transmitter is not already communicating with another receiver. The binding process needs only to be done once for each receiver.

8.3.1 Standard pairing procedure

- 1.** Switch off the transmitter and receiver.
- 2.** Plug the „**BIND PLUG**“ into the **EXT** receiver input.
- 3.** Connect receiver power supply.
- 4.** Switch on the transmitter. The receiver will bind with the primary transmitter module.

8.3.2 Alternative pairing procedure through the transmitter menu

1. Turn off the receiver. Keep the transmitter turned on.
2. Plug the **"BINDPLUG"** into the EXT receiver input.
3. Connect receiver power supply.
4. Locate the transmitter menu **„Advanced Properties -> Wireless Modes/Trainer“**
5. Highlight **"Pair primary TX module"** and press the **„3D button“**.
6. The receiver will bind with the transmitter. Confirm the registered device.

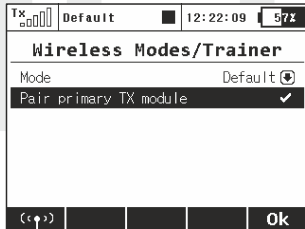

8.4 Range Test

The range test will verify that the transmitter and receiver are functioning properly.

Before the first flight of each flying session or if have any doubts about the transmitter or receiver function, you should always check the range. During the range test the transmitter's output power is decreased to 10%.

When performing a range test, both the model and the transmitter should be at a minimum height of 80 cm (31.5") above the ground. A correctly functioning transmitter and receiver in range test mode should safely control a model to a minimum distance of 50m (164'). If not, check your model's antenna installation first. If the test is still not successful, don't fly the equipment and contact your retail shop or one of the JETI authorized service centers.

8.5 Fail safe

All Duplex 2.4GHz system receivers are equipped with **„fail safe“**; a function which reacts to control signal transmission interruptions. When your receiver for any reason does not receive transmitter information, it changes, after a pre-set time period, to one of the following modes.

„Repeat“ – This mode holds the last valid control throw signal (this is the default mode for all receivers)

„Out off“ – There is no output signal provided by the receiver, i. e. servos do not keep their positions

„Failsafe“ – receiver outputs change to preset positions

Each receiver channel can be configured to one of the modes described above. We recommend that you setup „fail safe“ positions for every output, which enables your model to stay in a stable condition. For instance, the elevator and rudder in neutral positions, electric motor switched-off, gas engine idling, spoilers extended.

Configuration Method of the receiver failsafe function.

1. Bind receiver with transmitter. **See chapter: 8.4 Binding.** Leave receiver and transmitter in switched-on condition.
2. In the transmitter, go to the menu „**System->JETIbox**“ and proceed according to picture. Use the **F1-F4** function buttons to move within the menu.
3. In the „**Set Output Pin**“ menu select the receiver output which you want to configure (use the left/right buttons) and proceed (by using the down-button).
4. In the „**Signal Fault Yn**“ menu where n denotes the channel number which has to be configured, use the right-button to edit the output function showing a signal failure (setup „fail safe“). You have now activated the „**fail safe**“ function on receiver channel output n.
5. The „**fail safe**“ is adjusted by pressing the down-button and changing to the „fail safe“ menu. With the left/right buttons edit the „**fail safe**“ value in a range of 0.8ms to 2.2 ms. Adjust all of the connected receiver outputs by repeating steps 3-5.

The last parameter to be set up is the elapsed time after signal failure when the „fail safe“ or other actions after signal failure will be initiated. In the „**SignalFault Delay**“ menu you can define the length of time after a signal fault occurs in which the preset throws are applied. The values in this menu are changed by pressing the left/right buttons.



8.6 Technical data receivers

8.6.1 Technical data receivers outside the U.S.

* External Power Connector

Basic Data	R4	R4C (R4C mini)	R5L	R6 (R6 EPC*)	R7 (R7 indoor)	R8 (R8 EPC*)	R9	R10	R11 EPC*	R12 EPC*	R14*	R18*	Rsat2 (RMK2)
Dimensions [mm]	35x 20x7	30x23x13	47x20x7	45x24x12	44x20x7	50x30x12	51x24x11	50x28x13	51x24x11	50x28x13	62x38x16	62x38x16	35x23x6
Weight [g]	4,8	8 (7)	5,4 (5)	11 (14)	5,5	15 (18)	13	17	15	22	30	30	12
Antenna Length [mm]	2x100	1x200 (internal)	2x100 (2x45)	2x100	2x100 (2x45)	2x200	2x200	2x200	2x200	2x400	2x400	2x400	2x200 (2x75, 2x150)
# of Channel Outputs	4	4	5	6	7	8	9	10	11	12	14	18	PPM 8/16
Temperature Range [°C]	-10 to +85	-10 to +85	-10 to +85	-10 to +85	-10 to +85	-10 to +85	-10 to +85	-10 to +85	-10 to +85	-10 to +85	-10 to +85	-10 to +85	-10 to +85
Supply Voltage [V]	3.2 – 8.4	3.2 – 8.4	3.2 – 8.4	3.2 – 8.4	3.2 – 8.4	3.2 – 8.4	3.2 – 8.4	3.2 – 8.4	3.2 – 8.4	3.2 – 8.4	3.2 – 8.4	3.2 – 8.4	3.2 – 8.4
Average Current [mA]	40	40	30	45	40	30	30	30	30	30	40	40	30
Real Time Transmission of Telemetric Data	Yes	Yes	Yes	Yes	Yes	Yes	Yes	Yes	Yes	Yes	Yes	Yes	Yes
Programming	JETIBOX	JETIBOX	JETIBOX	JETIBOX	JETIBOX	JETIBOX	JETIBOX	JETIBOX	JETIBOX	JETIBOX	JETIBOX	JETIBOX	JETIBOX
Support Satellite Receiver Rsat	no	no	no	no	no	no	Yes	Yes	Yes	Yes	Yes	Yes	-
Power Output [dBm]	6	6	15	15	6	15	15	15	15	15	15	15	15
Receiver Sensitivity [dBm]	-98	-98	-106	-106	-98	-106	-106	-106	-106	-106	-106	-106	-106

8.6.2 Technical data receivers for the U.S.

*** External Power Connector**

Basic Data	R4L (R4L indoor)	R5L (R5L indoor)	R6L (R6L indoor)	R7plus	R9	R11 EPC*	R14*	R18*
Dimensions [mm]	38x20x7	47x20x7	43x24x11	51x24x11	51x24x11	51x24x11	62x38x16	62x38x16
Weight [g]	4,8 (4,5)	5,4 (5)	13	13	13	15	30	30
Antenna Length [mm]	2x100 (2x45)	2x100 (2x45)	2x200 (2x50)	2x200	2x200	2x200	2x400	2x400
# of Channel Outputs	5	5	6	7	9	11	14	18
Temperature Range [°C]	-10 to +85	-10 to +85	-10 to +85	-10 to +85	-10 to +85	-10 to +85	-10 to +85	-10 to +85
Supply Voltage [V]	3.2 – 8.4	3.2 – 8.4	3.2 – 8.4	3.2 – 8.4	3.2 – 8.4	3.2 – 8.4	3.2 – 8.4	3.2 – 8.4
Average Current [mA]	30	30	30	30	30	30	40	40
Real Time Transmission of Telemetric Data	No	Yes	Yes	Yes	Yes	Yes	Yes	Yes
Programming	Tx	JETIBOX	JETIBOX	JETIBOX	JETIBOX	JETIBOX	JETIBOX	JETIBOX
Support Satellite Receiver Rsat	no	no	no	Yes	Yes	Yes	Yes	Yes
Support PPM/EX bus	Yes	Yes	Yes	Yes	Yes	Yes	Yes	Yes
Power Output [dBm]	15	15	15	15	15	15	15	15
Receiver Sensitivity [dBm]	-106	-106	-106	-106	-106	-106	-106	-106

8.7 Using Device Explorer To Configure the Receiver



The Device Explorer utilizes the latest data/command **EX Bus** protocol to wirelessly configure remote devices such as receivers, sensors and other **EX Bus** compatible devices. You can check the label of your device to see if it supports the **EX Bus** protocol.

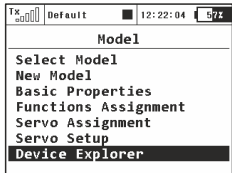

Basically, the Device Explorer (located in the Model menu) replaces the integrated JETIBOX emulation and brings additional, more intelligent ways to communicate with your remote devices. The main Device Explorer window shows a list of available

devices. The recognized devices are labeled with their registered name, others are not displayed or only displayed as a device ID. The check mark tells you that the device is ready and that you can configure it. By using the „F3" Refresh button you can reset the displayed devices, this forces the auto-detection function to explore all attached devices. The remote sensor and device detection process is always running in the background.

In the picture above, two receivers – R8 EX and R9 EX – have been detected and are recognized. When you press the rotary button, you are able to configure them in detail. Here is the example how to use the Device Explorer to configure an **"R8 EX"** receiver:

First, the transmitter downloads all settings from the receiver. After that operation is completed you should be able to see the basic configuration of the receiver as shown in the picture **a)**. Every modification that you make is automatically uploaded back to the receiver, so that you can immediately see results of the steps you are

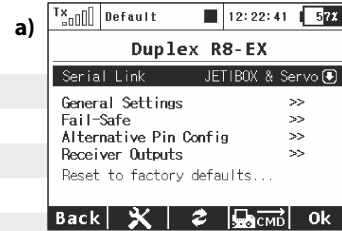

doing and there is no need to continuously **"save"** your changes. For your convenience, there is a **"Refresh"** button „F3", which causes all of the data to be downloaded from the receiver once again. This is beneficial mainly if you are modifying the configuration by using a JETIBOX device and the Device Explorer simultaneously.

The **"F2"** Tools button is used to enter a special dialog where you can import and export settings of the particular device. If you want to export the configuration of your (for example) receiver, just enter the **"Export settings"** menu item, set the file name and confirm. Similarly you can import this configuration to the device. All the exported files are stored in the **"Export"** folder on the SD card.

Note: Before a device can be recognized, a special predefined configuration scheme must be present on the SD card in the /Devices folder. If the scheme doesn't match or doesn't exist, an error message "Unknown device" is displayed. If such an error occurs, please download the latest software for your DC/DS which, by default, has all the definitions included, or contact your dealer for assistance. This text describes properties introduced in receiver version 3.20.

The picture a) shows the following adjustable parameters:

- **Serial Link** – This determines the operational mode of the receiver. You can choose from these options:

- **JETIBOX & Servo** – The standard mode for direct servo control.
- **PPM Positive, PPM negative** – the servo signal is summed into a standard or inversed PPM signal. This option is for devices which can use single line servo output data. Direct connection of servos in this mode is supported as well.
- **EX Bus** – Tells the receiver that it should send all data onto a fast digital serial link for further processing. This is the recommended option if you are connecting the receiver to the Central Box or another **EX Bus** intelligent device.
- **UDI - Universal Data Interface.** - This is a unidirectional digital serial protocol that can transmit up to 12 channels on a single wire. The UDI is compatible with several stabilization systems for helicopters and airplanes.

- **General Settings** - redirects you to screen b)

- **Fail-Safe** - redirects you to screen c)

- **Alternative Pin Config** - redirects you to screen d)

- **Receiver Outputs** - redirects you to screen e)

- **Reset to factory settings...** – After confirmation, the receiver's configuration will be restored to its factory settings.

The next page (General Settings) shows basic properties of the receiver (picture b).

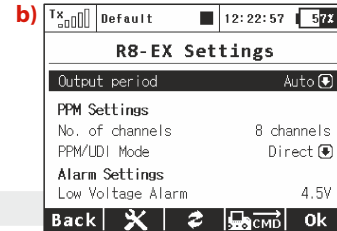

- **Output Period** – Determines how often the servo signal will be repeated to the outputs of the receiver. You can select periods from 5ms to 30ms (in 5ms steps). Recommended option: „Auto“.

PPM Settings

- **Number of channels** – if the output mode selected is either positive or negative PPM, you can set how many channels will show on the output.

- **SAT1/SAT2** - Some types of receivers support input of backup PPM signal. This signal can be captured via SAT1 or SAT2 ports. Here you can define the mode of operation for the particular ports. The PPM input can be accepted only in standard servo mode and EX Bus mode. Additionally, the SAT2 port can be configured as a PPM output. In this case the SAT2 outputs all 16 channels if not specified otherwise.

- **PPM/UDI Mode** - determines processing and additional logic applied to the PPM and UDI protocols.

- **Direct** - signals received from the transmitter are not further on processed in the receiver, they are generated without any change at the output of the receiver in form of PPM/digital signals. If a signal loss occurs, no PPM/digital data will be generated by the receiver.

- **Computed** - the signals received from the transmitter can be processed further on in the receiver and its menus "Channel set" and "Out Pin Set" programmable channel outputs, gains etc.)

Alarm Settings

- **Low Voltage Alarm** - the value serves for the setup of the alert decision threshold. As soon as during operation the actual voltage decreases below the set threshold, the receiver will generate an alarm. The transmitter may announce this situation by an acoustic tone (this depends on transmitter alarm settings, please refer to chapter describing „Timers/Sensors->Alarms“).

On the next page (picture c)) shows the fail-safe function parameters.

- **Fail-Safe** – This parameter tells the receiver how to react when a signal loss event occurs. If you set **“Enabled”** then you will be able to set the behavior of every channel independently. The **“Disabled”** option says that if no signal is being received from

the transmitter, no driving signal for the servos (or PPM) will be present.

- **Fail-Safe Delay** – The number of seconds that must elapse from the moment of losing signal until the fail-safe is activated. This option is available only if the Individual mode is selected.

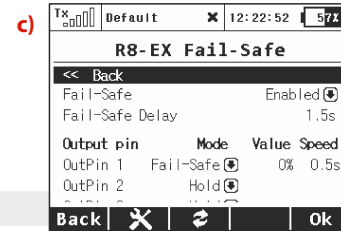

- **Each output position of the receiver has three adjustable parameters:**

• **Mode (Hold, Out OFF or Fail-Safe)** – Dictates, how the specific output behaves if a signal loss occurs. Using the Hold mode, the latest known servo position will be held. Out Off option means that there will be no signal to the particular servo channel. The last option, Fail-Safe, will set the servo to (user) predefined position (set in the **“Value”** column).

• **Value** – The position of the servo after a signal loss occurs. This is available only when the Fail-Safe mode is selected. For convenience, you can press the **„F4 Apply”** button while you are editing this column. The selected value will then appear directly on the servo output without the need to turn off the RF modules which would eventually activate the fail-safe and show the set position. The **“Apply”** function makes it faster to set your fail-safe positions.

- **Slope** – This slows down the speed of servo movement while the output is moving from the normal position to the fail-safe position.

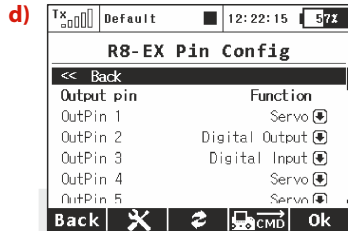

The screen d), "Alternative Pin Config", allows you to modify the modes of receiver output pins. The servo outputs can be configured into Digital input and Digital output modes.

- **Digital input mode:** a logical value of a given signal pin (0 or 1 as a result) is transmitted to the DC/DS in form of EX telemetry so that it can be further on processed (displayed and stored to the SD card). The receiver pins are equipped with internal pull-up resistors. To detect logical value of a given pin it is enough to connect the signal pin with the ground.

- **Digital output mode:** The channel value of a given output pin is discretized into two values. If the channel value is greater than 1.5ms, the pin output will be log.1. Otherwise the signal pin will stay at logical 0. Using this way you can simply control for example lights consisting of several LEDs. The fail-safe configuration is applied in this mode as well as in servo mode.

The page Receiver Outputs (picture e) allows you to redirect your transmitter's channels to any output of the receiver. For convenience the transmitter's channel numbers are displayed together with the appropriate function names, making it easier to adjust. In addition, you can also set the servo group for each channel. For more information please refer to your receiver manual.

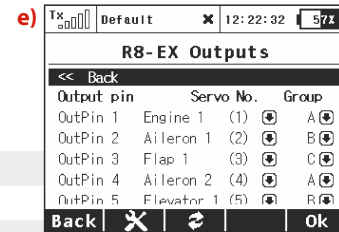

8.7.1 Support of remote commands for EX Bus devices

(*depends on equipment)

The DC/DS transmitters support up to 16 universal commands for wirelessly connected devices supporting EX Bus. To view the list of active commands, press the „F4” CMD button when in the „Model -> Device Explorer” menu. However, the command must be detected before it can be activated. As an example of the use of wireless commands, the Central Box can be used and its command that resets the minimum, maximum values and battery capacity (Clear MIN/ MAX values).



1. The list of active commands.

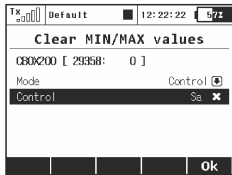

2. Sa switch is assigned to reset minimums, maximums, and the measured capacity. For the reset command only the Control mode is available (the position of the control/switch is taken as an input), other devices may accept a proportional value specified as a constant or as the channel number on the transmitter.



3. Scroll to view minimums and maximums.



4. Pushing the „3D” button enables you to add the command into the list of active commands and it is possible to assign a transmitter control to it.

On the main screen of the Central Box settings scroll down to display the maximum telemetry values (Telemetry Min/Max). Here you will find a choice to assign a switch to the command for deleting measured minimums and maximums (Clear Min/Max switch). Pushing the „3D” button on this item you are moved to the list of active commands where this command is already listed and is inversely highlighted with a cursor.

Pushing the „3D” button moves you to the choice to assign the control/switch that will further on take care of the command for resetting. Here we have chosen the Sa switch.

Further operation of the command will look like this:

- Moving the Sa switch into the ON position makes the transmitter detect that it should send the command for resetting telemetry minimums and maximums to the model. However, before the command is applied, it is necessary to confirm the choice by the pilot to avoid unwanted resetting of the data.

- The transmitter displays a dialog asking if you want to execute the command for resetting the telemetry. If you press NO or you do not manage to respond in time, the dialog closes and the command is not executed.

- Conversely, if you press YES, the command is sent to the model where it is processed by the Central Box which resets its telemetry. The result of this command can be displayed on the main screen of the transmitter in the telemetry window – the item Capacity of the Central Box will now be set to zero.

Note: This text describes receiver properties introduced in DC/DS V3.0 and receivers version 3.20. Earlier versions of the firmware might offer different properties, or the described configuration might be entirely inaccessible. Receiver software is updated through a PC with the aid of the JETI USBa adapter. For more details refer to the USBa adapter manual.

8.8 RC-Switch

The RC Switch is a special wireless device that allows you to remotely connect or disconnect the receiver power supply of your model. There are currently two variants of the device: RC Switch and RC Power Switch. The difference is noticeable in the picture below. The simple **RC Switch** is suitable for applications where a **Central Box**, **Max Bec 2D** plus, **SBEC 40** or other intelligent electronic device is being used. It offers a single output pin that might be wirelessly driven high or low according to the situation.

When connected in place of a magnetic key, the RC Switch can turn the electronics in the model on and off.

The second variant, the RC Power Switch, can fully replace a standard physical switch. It can directly drive servos and electronics since it includes a couple of low-resistant MOSFETS. Just plug the RC Power Switch between the battery and the receiver, configure the switch-related settings in your transmitter and bind it as a standard receiver.

Variant of the RC Switch

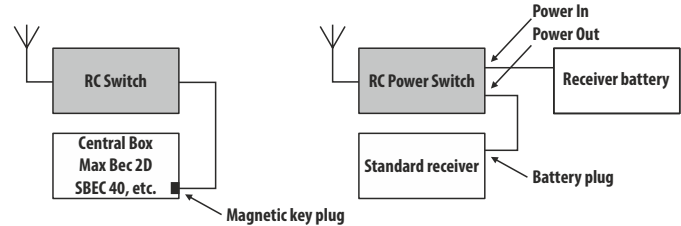

The switch-related settings are located in **Model->Device Explorer->RC-Switch**. First, you have to enable the switch by pushing the rotary button on your transmitter with the first row of the transmitter display highlighted.

Then you should bind the RC Switch:

- Put the bind plug into RC Switch and then turn it on.
- Push the rotary button with the **"Pair RC Switch"** row highlighted on your transmitter display.
- The ID of the switch is automatically saved.

The Transmitter control switch function is a source of events:

If you want to turn the model on, then flip the assigned control switch and confirm the question that appears. If you want to turn the model off, just flip the switch back and also confirm the question.

You can invert polarity of the switch (if high logical level doesn't turn the device on) and also set the audible signals that will be activated every time the status of RC Switch is changed (turned on or off).

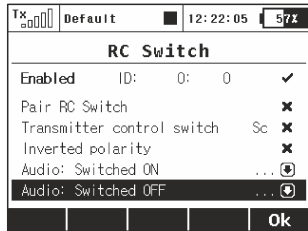

duplex

9 Main menu

You reach the basic menu from the main display by pressing the „menu“ key.

1. The main menu is divided into a **basic** and a **user** section. In the basic menu, the menu items are divided into sub-menus.

- Model
- Heli Tuning
(only for model helis)
- Fine Tuning
- Advanced Properties
- Timers/sensors
- Applications
- System

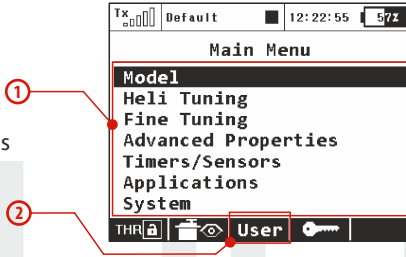

2. You enter into the user section of the main menu by pressing the „F3(User)“ button. In this section you may create a custom, user defined menu according to your needs.

3. In the basic setup the menu contains no items.

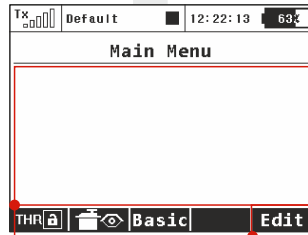

4. By pressing the „F5(Edit)“ button you will enter into the User Menu Setup section.



5. The numbers on the left side of the display shows the sequence of the menu items.

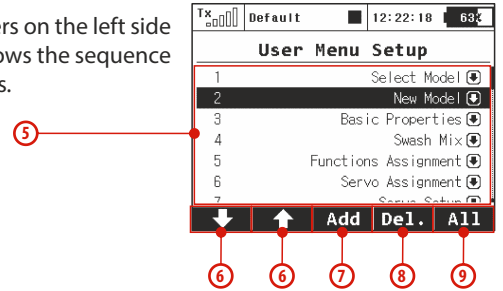

6. With the „F1“ and „F2“ buttons you may change the sequence of the selected menu items.

7. With the „F3(Add)“ you will create a new item in the user section of the main menu. By pressing the „3D button“ when the menu item is selected, you will change to the selection menu of that item.

8. With the „F4(Delete)“ button you will delete the selected menu item.

9. With the „F5(All)“ button you will insert all of the possible sub-menu items into the user menu.

In both sections there are functions like throttle lock and servo monitor which are accessible by using the „F1(THR)“ and „F2(Receiver output)“ buttons.

9.0.1 Password protection against accidental configuration changes

If you lend the transmitter to another person and you want to ensure that no changes in the model configuration that could influence the function of the transmitter or the model can be done, you can take advantage of the Model Lock function.

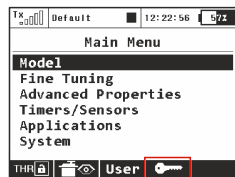

1. In the main menu, push the „F4" button to display the dialog for entering the one-time password.

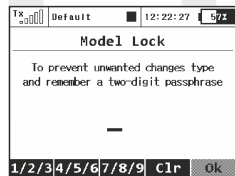

2. Here, enter the two-digit code using the "F1" 1/2/3, "F2" 4/5/6 and "F3" 7/8/9. This code appears on the display and will later be used to unlock the transmitter.

Pushing „F4" Clear enables you to delete the specified number and you can start up again.

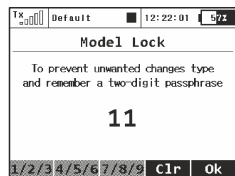

3. Remember the code and push „F5" OK. Now confirm the safety prompt "Apply changes?".

From now on the transmitter will be locked against:

- changes in configuration
- selection of the model
- creating a new model

- calibration of controls
- logging telemetry
- USB connection
- switching off

All the work with the SD card therefore takes place in read-only mode.

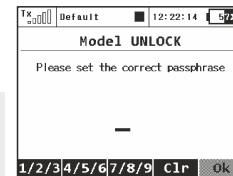

4. Unlocking the model is possible via the „F4" button in the Main Menu. Now you need to enter the same code as when locking the model. Confirm with „OK" button.

Now you are asked whether you want to save the changes to the configuration of the model or not.

Pushing „F1" NO button makes all the changes discarded and all the data from the SD card will be reloaded.

Note: This function cannot in any case be used to increase safety, eg. against the theft of the transmitter. The transmitter is locked against configuration changes from the moment you enter the code until the transmitter is subsequently switched off or the code is re-entered. As soon as the transmitter is switched off, (eg. pushing the combination of POWER+ESC or removing the power supply), the transmitter is automatically unlocked.

9.1 Model

The „Model“ menu contains basic functions for working with your model, like:

- Select Model
- New Model
- Basic Properties
- Functions Assignments
- Servo Assignment
- Servo Setup
- Device Explorer

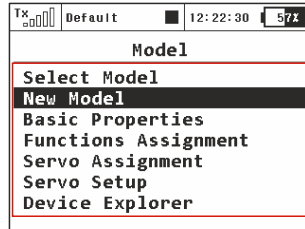

9.1.1 Model Selection

The menu displays a list of your models stored in the memory with their names, setup dates and model types. The currently selected model is marked by a check mark. In the menu you may select a model and manage all of your models. You can copy models, delete models (except for the currently selected model) and change the storage sequence of your models.

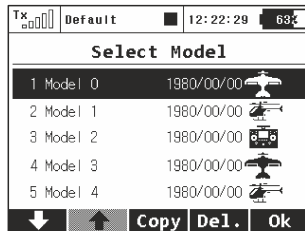

1. Model selection

In the list of models, select the required model and confirm it by pressing the „3D button“ or „F1(Ok)“ button. You will be prompted to confirm loading of the selected model.

The DC/DS transmitters offer a „Model checking“ function, which compares the series number of the receiver in the model profile with the series number of the receiver with which it is starting to communicate. If the two series numbers do not match, the transmitter displays a warning that a different receiver has been detected for the model. In this situation, you the user will decide whether to:

- Confirm the change – this assigns the new receiver to the model.
- Reject the change – the transmitter will not communicate with the newly detected receiver and model will not be switched on.
- Select another model from the transmitter register.

The information about receiver discrepancies will also be displayed after the creation of a new model and binding or establishing communication with the receiver.

Through the use of this function, if you choose, the new receiver will be assigned to the given model for future checks.

2. Copying a model

The complete setup information of a model can be copied and used to create a new model with the same programming. Select the model from the model list that you want to copy and then create the copy by pressing the „F3(Copy)“ button. You will need to edit the name of your copied model before it can be saved. Once you edit the

Note: *If you would like to make set-up changes in an existing model, you should first make a copy of the original setup. This will help you if you would like to return to the original model setup.*

name, press the „F5(Ok)“ button to continue. Your model copy will appear at the end of your model list.

Note: *If you would like to copy a model from one transmitter to another you should notice that the transmitters may not have the same software equipment, so the configuration of activated modules may not match each other. In this case it is necessary to check the individual functions of the model, since an attempt to load the model file by another transmitter may end up with an error message (see System -> Installed Modules).*

3. Deleting a Model

A model can be removed from the memory. In the model list select the model you want to delete and press the „F5(Delete)“ button. For safety reasons it is impossible to delete the currently selected model.

4. Choice of model sequence

The sequence of models can be changed by using the „F1()“ button to move the selected model one position downwards or by using the „F2()“ button to move the model one position upwards. The transmitter allows storing of many models in the memory.

Note: *Try to arrange your most frequently used models at the beginning of the model list in order to avoid having to browse the whole list when selecting a model.*

9.1.2 New Model

Selecting this menu item starts the new model creation assistant. The assistant begins creating a new model profile as soon as you select „New model“. However, the new model will only be created after the confirmation in the last assistant menu, „Servo Assignment“. Until you make the final confirmation, the new model is NOT created or stored in the memory.

The setup possibilities of the DC/DS transmitters are very extensive. For simplicity, some of the possible adjustments are accessible only for certain combinations of wing and tail arrangements, aerodynamic brakes, landing gears, and number of motors or engines.

Note: *For safety, start creating a model with the receiver in the model switched off. Be careful when handling electric models or servo binding, where an improper linkage connection may cause damage when power is applied. When handling electric models it is safer to remove the propeller or disconnect the motor during model creation and tuning.*

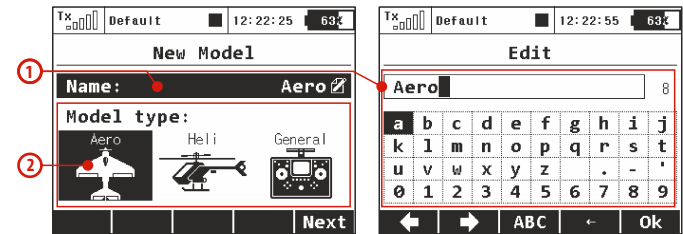

1. Model name

Use the „3D Control Selector“ to select the model name menu. You

will enter the model name that you want the transmitter to use when the model is stored in the transmitter's memory. The maximum available space for a model name is 12 characters, including spaces.

When you select the „Name“ item, the screen will change into the „Edit“ menu, where you can use the „3D button“ to enter a name for your model. Use the „F1()“ and „F2()“ buttons to move the cursor, if needed, within the name box.

Use the „F3(ABC)“ button to change between lower case letters and capital letters.

Use the „F4()“ button to delete the character at the current cursor position.

When you finished editing your model's name, use the „F5(OK)“ button to confirm the name and return to the „New model“ menu.

The model name can be changed even after the model is stored by going to: „Main menu->Model->Basic configuration“ and selecting the model name.

2. Model type

The model type selection makes the setup of your model more efficient by populating the menus with many of the popular options for each type of model. The possible choices are: Aero, Heli and General. Once your model is stored it is not possible to change that model's type.

Once your model's name is entered and the type is selected, press the „F5(Next)“ button to go to the next menu assistant step: „Basic Properties“. The software will only allow this step if both the model name and type have been set up.

9.1.3 Basic configuration - AIRPLANE

In this menu you will setup the wing configuration, tail type, number of motor/engines, number of spoilers, and number of landing gear servos. Your model's flight control functions are generated according to your configuration choices in this menu and the necessary fixed mixers become accessible.

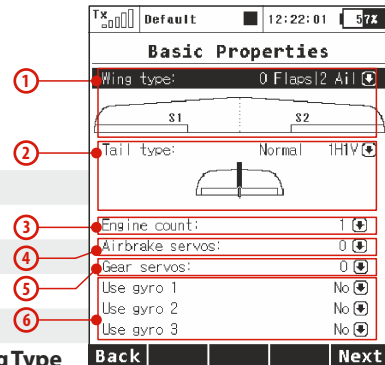

1. Wing Type

The following wing type options are available:

Type	Description
0FLAP 1AIL	Only one aileron servo
0FLAP 2AIL	Two aileron servos
1FLAP 2AIL	One flap servo, two aileron servos
2FLAP 2AIL	Two flap servos, two aileron servos
2FLAP 4AIL	Two flap servos, four aileron servos
4FLAP 2AIL	Four flap servos, two aileron servos
4FLAP 4AIL	Four flap servos, four aileron servos

2. Tail Assembly

The following tail option are available:

Type	Description
Standard 1H1V	Standard tail assembly with one horizontal control (elevator) and one vertical control (rudder)
V-tail 2H	Traditional V-tail
	Note: The V-Tail Mix is automatically enabled.
Ailevator 2H1V	Tail assembly with two elevator servos and one rudder servo
	Note: The Ailevator Mix is automatically enabled.
Standard 2H2V	Tail assembly with two elevator servos and two rudder servos
None – Elevon/Delta	The model is controlled by the combined control of the wing surfaces
	Note: The Delta/Elevon Mix is automatically enabled.
None	Model without a tail assembly

3. Number of Engines/Motors in the model

You can select the number of engines/motors in the model. You can select up to 4 engines/motors. You can then assign the control of each throttle to a different receiver channel if needed.

4. Number of Spoiler Servos in the model

You can select up to 2 spoilers servos. You can then assign the control of each spoiler to a different receiver channel if needed.

5. Number of Landing Gear Servos in the model

You can select up to 4 landing gear servos. You can then assign the control of each landing gear servo to a different receiver channel if needed.

6. Use gyro (1-3)

It is possible to create up to three independent functions for controlling gyro gain. The detailed configuration of individual gyro gains is then available in „**Fine Tuning -> Gyro Setting**“.

Press the „**F5(Next)**“ button proceed to the next step of the menu assistant: „**Functions Assignment**“.

Note: If you activate the additional function of the gyro in the active model, after leaving the Basic Properties menu it is necessary to carry out the control assignment (Functions Assignment) and then select the appropriate output channel (Servo Assignment).

9.1.4 Basic Configuration - HELICOPTER

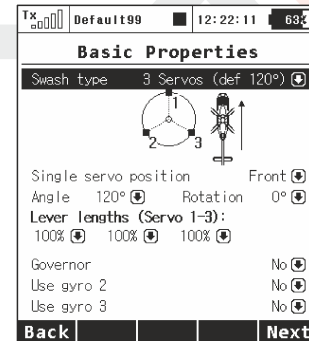

Swash Plate Type

Enter the type of swash plate your helicopter is using. Refer to your helicopter's manual if necessary.

- **„3 servos (default 120°)“** – the swash plate controls the elevator, aileron and collective pitch functions by coordinating three servos. In the swash plate configuration, the servo control points can be shifted closer to or farther away from each other around the main shaft axis using a parameter "Lever length". In case your heli requires a swash plate configuration of 3 servos (140°) or 3 servos (90°) you can use the parameter angle with 1° increments.

Within this menu you can also change the effective swash plate servo „lever lengths“ to compensate for any nonlinear servo arm travel.

- **„4 servos (90°)“** - the swash plate controls the elevator, roll and collective pitch functions by coordinating four servos in 90° orientation. You can make the same changes to this type as with the swash plate described above.
- **„Mechanical“** - this swash plate type uses a single servo for each flight function. This is the swash plate type to select if you are using a flybarless controller.

Reverse swash plate orientation by 180°

The **„Front servo position“** item is accessible only for the swash plate type **„3 servos (default 120°)“**. If your helicopter requires, it is possible with a single button to turn the swash plate configuration in the setup by 180°.

Swash plate angle

The **„Angle“** item is only accessible in the **„3 servos (default 120°)“** swash plate type. The angle formed by swash plate points 1 - 2 and 1 - 3 can be configured by the user in 1° increments. This allows you to fine tune your swash plate configuration as needed.

Rotation

The **„Rotation“** Item is only accessible in the **„3 servos (default 120°)“** and **„4 servos (default 90°)“** swash plate types. This item allows you to rotate the entire swash plate by a defined angle. This allows you to add fine tune your swash plate as required by some scale models.

Servo arm lengths (servo 1 – 4)

This item allows you move your swash plate control points either closer to or farther away from the axis of rotation. This allows you to compensate for any nonlinear servo movements.

Governor

In some helicopter setups a governor function is used for motor control – this allows the motor to run at a constant speed independently from any collective pitch. If your model helicopter setup includes a governor which can be controlled through the receiver then switch on this function. Once you enable this function, the governor configuration becomes accessible in the **„Fine Tuning -> Governor Setting“** menu.

Use gyro (2 - 3)

It is possible to create up to three independent functions for controlling gyro gain. By default, gyro No. 1 is always active. The others are activated in the **„Model -> Basic Properties“** menu together with the Governor function.

Note: *If you activate the additional function of the gyro in the active model, after leaving the Basic Properties menu it is necessary to carry out the control assignment (Functions Assignment) and then select the appropriate output channel (Servo Assignment). Setting the gyro gain itself is carried out in the „Fine Tuning-> Gyro Setting menu“.*

9.1.5 Swash mix

Here is where you set up the swashplate CCPM (=Cyclic/collective pitch mixing) throws for Aileron, Elevator and Pitch. You can fine tune each of these functions by changing their percentages. If needed, you can reverse the throws by setting a negative percentage.

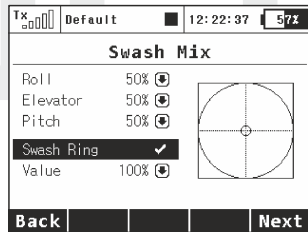

Swash Ring

It is possible to activate the function of the cyclic limitation for a helicopter rotor head. Activating this function causes the restriction of servo travel in the combined full deflection of the roll and pitch controls so that the total size of the deflection is always within the inner area of the displayed circle. Outside the circle there is a kind of a dead zone of the flight controls.

Editing an item **"Value"** affects the diameter of the displayed circle, ie. size of the maximum allowed deflection. The setting is global for the whole model.

9.1.6 Basic Configuration-GENERAL

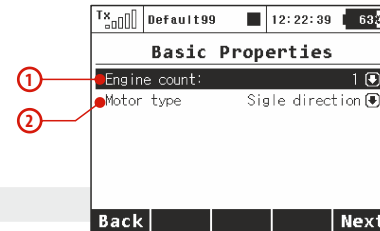

1. Number of Motors in the Model

This is where you select the number of motors in your model. It is possible to select 0-4 motors. The number of transmitter control outputs used to control the motors are automatically increased or decreased according to number of motors that you select.

2. MotorType

Do the motors in your model only turn in one direction or are they able to rotate in both directions?

9.1.7 Assignment of functions

Based on your selected configuration a list of all flight functions will be created with basic transmitter channel assignments.

The menu allows you to rename flight functions, assign a flight function to any arbitrary transmitter stick, switch, knob or slider and also allows you to set up additional flight function trims.

You can allow the software to automatically assign your flight functions by pressing the „F2(Auto)“ button and then press the „F5(Yes)“ button.

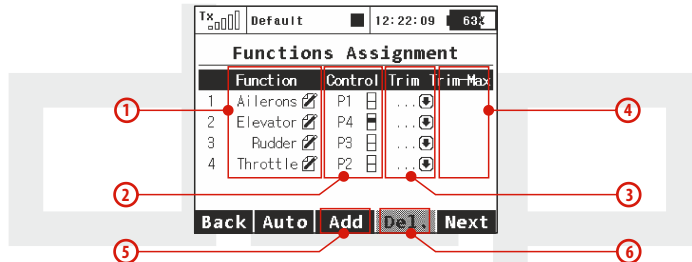

1. Flight function Renaming

By editing each „Function“ item you can rename a flight function from its original name to any name that you choose.

2. Assignment of a Control Element to a Flight Function

By editing each „Control“ item you can assign any arbitrary stick, switch, knob or slider to a given flight function. The proportional channels 1 – 8 are marked P1–P8. The markings Sa-Sj designate switches with the same designation as on the transmitter front panel.

When you select one of these items, you will enter the menu: „Select control input“, see chapter 9.7. The assignments can easily be verified by the graphic found beside the control element description in the „Control “ section, which shows the actual setup of the assigned control element.

3. Choice of an Additional Trim

The transmitter allows you to also create a trim function for any arbitrary flight function. By editing one of the „Trim“ items you can assign an arbitrary control element (stick, switch, knob or slider) to control the trim of the selected flight function. When you select one of these items, you will enter the menu: „Select control input“, see chapter 9.7. The assignments can easily be verified by the graphic found beside the control element description in the „Trim “ section, which shows the actual setup of the assigned control element.

The trim functions for the gimbal sticks P1-P4 are automatically assigned to the quad push-buttons located below the gimbals. It is not necessary to assign them manually.

4. Range of Additional Trim

If you set up a trim function, you can use the „Trim-Max“ to set the maximum trim influence on the given flight function. The default value is 50%. If you set the value to 0%, the trim control element will not have any effect on the flight function at all. If you set a value of 100%, the trim control element will control the flight function to its full travel.

5. Adding a Function

With the „F3(New)“ button you can create (add) your own flight function.

6. Deleting a Function

With the „F4(Delete)“ button you may delete the selected flight function.

Make sure that you have assigned all of your flight functions to the correct transmitter control elements (stick, switch, knob or slider) and make sure that the trims are assigned and functioning as you wish. By pressing the „F5(Next)“ button you will enter the next assistant step, the „Servo assignment“ menu.

Note: The initial assignment is carried out in accordance with your selected transmitter mode. If the initial assignment is incorrect, check the transmitter mode setup in the „Main menu->System->Configuration->MODE 1-4 menu.

9.1. 8 Servo Assignment

This menu shows the assignment of transmitter output functions to the receiver channels. This assignment can be changed as you wish. The order number at the beginning of the column shows the channel number and the assigned transmitter output function is next to it. In this menu you can rearrange your output functions as needed, i. e. any transmitter function can be assigned to any of the receiver channels. The only restriction is the number of channels which the transmitter can control (16 channels). The transmitter can automatically set up your servo configuration based on your previous model setup. If you want the transmitter to automatically assign the servos in the same order as the last model that you set up, press the „F3(Auto)“ button and then press the „F5(Yes)“ button.

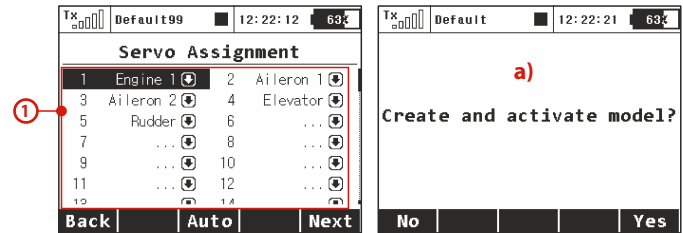

1. Assignment of Transmitter Output Functions to Receiver Channels

Select the required receiver channel and press the „3D button“. Now you can choose which function you want assigned to the selected receiver channel.

With the „F5(Next)“ button you will enter the next step of the assistant which creates and stores the model into transmitter memory.

a) The assistant asks you to confirm the creation of the model by displaying the question „Create and select a model?“. If you answer by pressing the „F1(No)“ button, the model will not be saved and you will return to the assistant to continue with further configuration of your model.

If you press the „F5(Yes)“ button, the model will be stored in the memory and at the same time will be activated. After that, you are automatically taken to the „Servo Setup“ menu. Your stored model can, of course, at any time be configured by selecting the „Main menu->Model“>„Servo Setup“ menu.

Advice: Once your model is created and activated, you should bind your receiver with the transmitter and then proceed with „Servo Setup“.

9.1.9 Servo Setup

This menu is for the additional tuning of output functions of the **transmitter->receiver channels->servos**. The assignment of a transmitter output function to a receiver channel is shown in the upper part of the menu (first item below the menu description).



1. Display of a Receiver Channel Throw

In the upper part of the menu the actual throw of the selected channel is displayed using a live graphic. If you make a change to your setup in this menu, you will immediately see how the output will be influenced by the change.

2. Selection of Receiver Channel

In the first position F1 in the lower bar you see the actual selected channel. With the **F2()** or **F3()** buttons or by editing the item „Servo #“ you will select the receiver channel which you intend to configure.

3. Center (Subtrim)

With this item you can adjust the servo neutral position of the selected receiver channel.

Advice: When building a model try to mechanically adjust the neutral positions as perfectly as possible. If you are going to use a high „Center (Subtrim)“ value in order to set up a servo neutral, the resulting servo throw will be restricted.

4. Max Positive/Max Negative Throw

This item sets the useable end points of the transmitter output function, i.e. how far the transmitter control element can move each surface. This function is used to set your maximum control throws for flight and to limit any potential binding of a linkage or surface. This limit can be exceeded by the use of mixes or combined functions.

Note: The size of the maximum throw can influence trim settings, dual rate throws and other proportional setups.

5. Max Positive/Max Negative Limit

These restrict the absolute throw of the receiver channel output. This limit can never be exceeded by any combination of functions or mixes.

Advice: You can adjust the throw limit to prevent a surface or linkage from hitting a mechanical stop or to prevent the servo from over-driving its mechanical throw range. This allows you to prevent mechanical servo damage.

6. Servo Reversing

Use this item to reverse the direction of a servo's travel.

7. Delay of positive/negative

This item allows you to delay the servo channel's travel time between both end points. This can be defined for the positive and for the negative value (each travel direction). For instance, the opening of a landing gear can be slower than when it retracts.

Advice: This function is great for timing retract gear servos.

9.1.10 Servo balancer *(*depends on equipment)*

The function of the servo balancer is designed for large models that have control surfaces driven by mechanically linked servos. Since each servo can be preset from the factory in a different way and mounting servos into the model is not always accurate, it is now possible to set servo travel algorithmically to ensure minimum mechanical stress during the movement of the controls.

Thus it is possible to assign a separate curve to each output channel, which is applied as the last operation before sending the deflections to the model. Because it is applied last, the curve is ultimately applied to trims, mixes, dual rates, etc., so that servos of the same control surface always move together equally. The Servo balancer can alter the curve of the servo by a maximum of $\pm 10\%$ with a resolution of 0.1%.

1. After you highlight the graph of the servo balancer, push the „3D button“. This enables editing of the servo curve. Now, always one control point is highlighted according to current servo deflection. If the current servo position is -30%, the nearest highlighted control

point is located in -25%. It is then possible to move the point upwards or downwards by turning the „3D button“ to the right, or respectively to the left. In „Auto“ mode (the „F2 button“ is highlighted) simultaneous shifting of neighboring control points occurs, so that the resulting curve is precisely smoothed. Then you can select another control point by moving the servo control and alter this point until the mutual mechanical stress of servos during the movement is minimal.

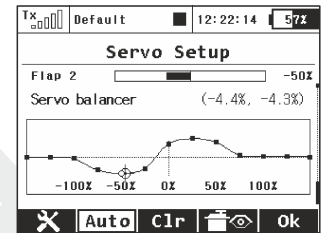
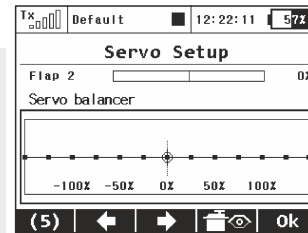

2. After pushing the „F1 button“ when the servo balancer is highlighted, the speed dial is displayed. Here is where you can select one telemetry parameter, which will appear at location of the digital clock on the top bar of the screen. This way you can select eg. displaying the instant current draw from the batteries, which is very helpful when balancing different servo travels.

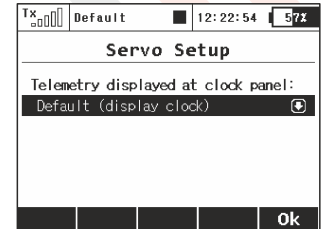

Note:

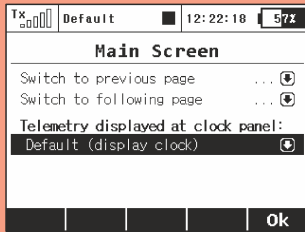

Setting the display of the telemetry data on the top menu bar of the screen is saved as a part of the model configuration and it is displayed again when the transmitter is switched on. Alternatively, it is possible to adjust the displayed data in the „Timers/Sensors -> Main Screen” menu. It is possible to select any simple numerical value, except GPS coordinates.

3. The „F2 Auto” button enables switching between automatic and manual selection of control points in the servo balancer edit mode. When selecting control points manually, push the „3D button” to move to the next point; pushing the „ESC” button activates the previous check point. When editing in the manual mode, you move (as opposed to the automatic mode) only one control point, the others remain unchanged.

If the „F3 Clear” button is pushed for a short time, it quickly clears a control point (which must be highlighted). If the „F3 Clear” button is pushed and held for longer time, the whole curve is cleared to a default state.

Advice:

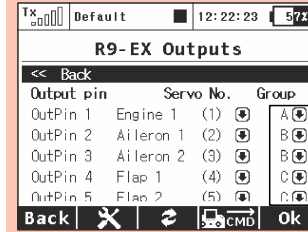

If you use several mechanically linked servos to control a single wing surface in the model as shown in this example, we recommend setting all the servos belonging to this surface into one output group (Group A-C). In the picture this is done via the Device Explorer application. In this way the servos will receive control pulses at the same time and their movement will thus be synchronous.

Advice: To optimize the servo travels via servo balancer, we recommend that you use an amperemeter (or eg. the current measurement from the MUI sensor displayed in the telemetry window) and always try to make sure that the current running through servos as low as possible.

9.2 Fine Tuning

- *Extended program functions for fine tuning your models*

- Flight Modes
- Digital Trims
- Flight Mode Trims
- Dual Rate/Expo
- Function Curves
- Aileron Differential (This menu is only accessible in the wing configuration 0FLAP | 2AIL and higher)
- Free Mixers
- V-Tail (This menu is only accessible in the „V-tail“ tail configuration.)
- Butterfly (This menu is only accessible in wing configuration 2FLAP | 2AIL and higher)
- Ailevator (This menu is only accessible in the „Ailevator“ tail configuration)
- Delta/Elevon (This menu is only accessible in wing configuration „None-Elevon/Delta“)
- Gyro/Governor
- Throttle Limiter (Helicopters only) (**depends on equipment*)
- Snap Roll

9.2.1 Flight Modes (**depends on equipment*)

The purpose of programming Flight Modes is to provide the ability to activate a group of settings that will optimize your flight control of your model. Flight Modes can just as easily represent settings for Take Off, Soaring, Landing and much more. They can be used in any particular situation where different settings of basic flight parameters is desirable. The DC/DS gives you the advantage of a wide variety of programming options.

Up to 10 different flight modes (depends on activated transmitter equipment) are available for every single model. Each one of these flight modes can be named differently for instant recognition. Only one of the flight modes can be active at any given time. With a little practice you will discover that creating your flight modes in logical order can prevent confusion in a critical situation. Flight mode control can be assigned to any of the switches, sticks, or knobs of the transmitter.

Flight Mode Configuration

- Some of the configuration settings come in two options. G-global (globe symbol) and S-Separate. Switching from G to S, system let you set up each flight mode individually.

Warning: When you switch from Global to Separate settings, all values will be copied directly to existing flight modes.

- If the flight mode configuration is set to S, each flight mode's values can be set independently from the other flight modes. When you switch to different flight modes, the pre-set position of an output (a control surface, for example) can be changed to optimize the control system of your model.
- Also, if the flight mode configuration is set to S, different variables for each function can be assigned to each flight mode. The assigned control switch can control multiple values within each flight mode.
- After creating a flight mode, this will become system wide settings for all future models.

Advice: If no flight mode is required, do not change the pre-set configuration.

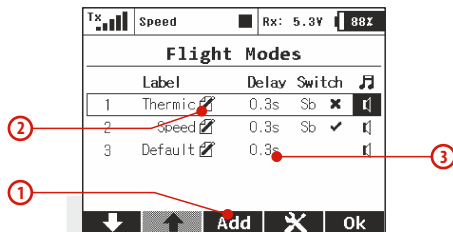

1. Adding Flight Modes

Pressing the “F3 (Add)” button creates a new flight mode. Simply highlight existing mode and press “F3 (New)” button. A copy confirmation menu appears on the screen, use the function keys to continue.

Press the “F5 (Yes)” button to create copy of the existing flight mode.

Press the “F3 (No)” button to create a new flight mode.

Press the “F1 (Esc)” button to be taken to main flight mode menu screen.



2. Naming Flight Modes

We recommend naming flight modes according to their function, for example: **Take Off, Soaring, Autorotation...**

Flight mode **names/labels** can be easily edited at any time.

3. Flight Mode Delays

The time delay function can help smooth the transition from one flight control state to another. Sudden changes in the positions of your control surfaces can negatively affect performance or even create a critical situation. The Time delay can help you avoid this situation.

Advice: If the desired result is not already tested or fully known (maiden flight), always make sure that you have set enough time delay for all of the changes to be implemented and that you have plenty of time to respond properly.

Warning: Throttle hold is not affected by the time delay. This function will always be performed instantly.

4. Flight Mode Activation

A flight mode can be activated by any control device (Switch/Knob/Stick). When you select a switch and by editing its desired assignment you can activate and pick the position at which this **Switch/Knob/Stick** or Logical Switch will turn flight mode ON or OFF (see chapter 9.7). You can use the visual indicator in the switch

column to help you determine the ON or OFF switch position for each flight mode.

- **Check Mark** – ON Position
- **X Mark** – OFF Position

When the flight mode is activated, the flight mode name can be seen at the top of the desktop screen.

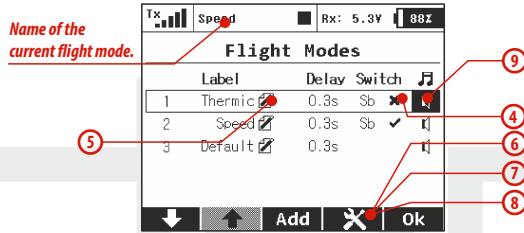

5. Flight Mode Activation Priorities

If you have created multiple flight modes that can match a given flight condition but that vary in their specific details (Landing in strong or light wind). You can create the order in which those modes can be turned on. The Numeric order will determine your priorities.

A lower number equals a higher mode priority. The initial flight mode has always the lowest priority.

6. Flight Mode Default and Reset

Any of the created flight modes can be pre-set as a future default. Simply highlight your choice and press the **"F4 (Opt.)"** button to see confirmation menu. Pick the, **"Set as a Default Flight Mode"** option and the flight mode is now set as your new default.

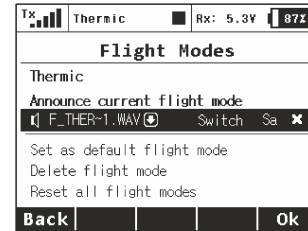

7. Deleting a Flight Mode

To delete a flight mode:

- Highlight the desired flight mode and press the **"F4 (Opt.)"** button to see the options menu.
- Scroll and select the **"Delete flight mode"** option and press the **"F5 (OK)"** button to make the final confirmation.

The initial flight mode is set as a default and can not be deleted.

8. Flight Mode Reset

All of the flight modes can be reset to basic settings at the same time. Simply highlight any flight mode and press the **"F4 (Opt.)"** button then use the **"Reset all flight modes"** option to reset all flight modes to their basic settings. All previous changes will be deleted and the flight modes will be reset to the G (Global) setting. This is useful when you are setting up a new model from a copied model and you want different flight modes.

Advice: After you make a configuration change or perform a reset, always check all flight modes.

9. Announcement of the current flight mode

It is possible to assign a WAV file to each flight mode, which is played at the moment when the selected mode is activated.

10. Flight mode announcement after flipping a switch

It is possible to assign an arbitrary switch to the flight mode voice announcement. After switching on, the actual flight mode will be announced (the selected WAV file will be played back).

9.2.2 Digital trim

Fully programmable digital trims are located right under the transmitter gimbals as a set of four directional buttons. All adjustments and step changes are made in the **"Digital Trim"** menu. You can assign different trim ranges and trim steps to every trim control function.

The trim dialogue has been divided into two **screens, a) and b)**. You can switch between each of them by using the **"F1 Left"** and **"F2 Right"** buttons. The **"F3 (Trim)"** button switches your desktop display to the main trim screen where you can instantly observe your setup changes.

As you can see from the screen **a)**, you can assign any function that will be influenced by that particular trim. It is also possible to deactivate the trim so that it doesn't influence any function (*simply unselect the assigned function*). This is mostly important for pilots of various multicopters or helicopters equipped with advanced stabilization electronics.

Special trim functions

Digital trims can be used independently as controls for any function. It is possible to assign the special functions **"Trim.Ctrl"** or **"Trim.RstOn"** (Trim – Automatic reset) to any digital trim.

- **Trim.Ctrl (Trim control)** – enables using a specific trim independently from model functions. The transmitter remembers

the trim value after shutdown. After pressing the trim button no superior functions are trimmed, only internal state of trim is incremented.

- **Trim.RstOn (trim control with automatic reset)** – enables using the specific trim independently from model functions. The transmitter does not remember the value of trim after shutdown. After loading the model, the trim value is always 0%. In combination with the logical switches this option is suitable for a sequential switching between flight modes or playing sound sequences.

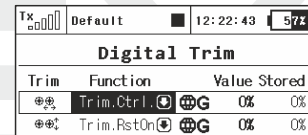

Trim	Function	Value Stored
⊕⊕	Trim.Ctrl	0%
⊕⊕	Trim.RstOn	0%

The operational modes of the trims have also been extended (see picture **c)**). There are currently these options:

Global – the specified trim will have equal settings for all flight modes.

Separate – every flight mode has its own independent configuration of the trim.

Advice: For the maiden flight we recommend using larger trim steps. After familiarizing yourself with your model's behavior you can switch to smaller steps for finer trimming.

Flight-Mode Group (A/B) – if you are using several flight modes and you want to share trim settings among a few of them just set one of the groups **FA** or **FB** for the particular trim. Each group has its own settings which are then shared. Note: If you change from Global to any Flight-Mode Group, the trim mode in other flight modes than the current one will become Separate.

Note: If you change a flight mode from Global to either of the Flight-Mode groups the trim mode for the rest of the flight modes (except for the one you are currently editing) will change to Separate.

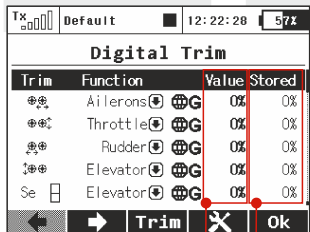

a)

1 2

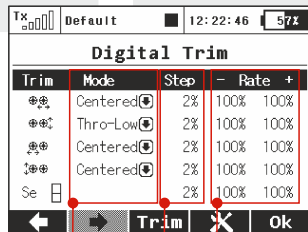

b)

3 4 5

The rest of the parameters are described below:

- 1. Value** – shows the actual trim rate.
- 2. Stored** – shows the stored value of trim memory function.

3. Mode – here you can specify a basic behavior of the trim:

- **Centered mode** – by default, the trim affects only the servo center, the endpoints remain untouched.
- **Linear** – shifts the whole servo travel, including endpoints.
- **Thro-Low** – affects the servo low endpoint and the entire curve, except for the high endpoint.
- **Thr-L50%** – affects the servo low endpoint and curve below 50%. This does not affect the curve above 50%.
- **Thro-High** – affects the servo high endpoint and the entire curve, except for the low endpoint.

4. Step – indicates, how much the value of trim changes each time the trim button is pressed.

5. Rate (+,-) – determines maximum limits used for the trim.

In the picture below you can see how various trim modes influence the servo output (trimmed to ca 50% of range). However, you cannot use any trim mode at any time:

V-Tail configuration - You can specify the trim mode only for the elevator function, not for rudder since these functions are linked together.

Delta/Elevon configuration - You can specify the mode only for ailerons, not for elevator.

Helicopter using CCPM mix - You can specify the mode only for pitch function, not for elevator nor roll function.

If you use two or more trims to adjust a single function, the resulting trim rate equals to a sum of all rates that are participating on this function. However, the transmitter uses always only a mode defined for the first trim.

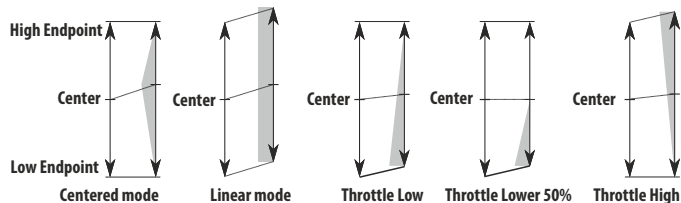

Press the **"F4 button"** to display additional trim options. See picture **d)**. You can store the currently highlighted trim (for example Ailerons in the picture) to trim memory, or you can apply the trim memory function to all trims.

How it works: The actual rate of the highlighted trim (or all trims, respectively) is copied into a special register. (See the last column of **picture a)**). Once the rate is stored, the trim rate column value will be cleared. This applies always to all flight modes. The trim memory function is beneficial if you want your trims zeroed although some offsets have been set. When processing, the transmitter sums the actual trim rate and its stored value.

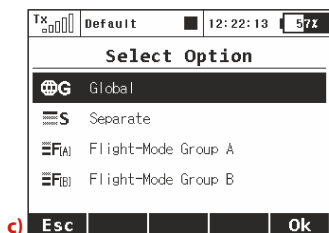

c)



d)

In the picture **d)**, there are two more options available: Clear highlighted trim and Clear all trims. After confirmation, this option clears the actual trim value (or all trim values, respectively) and similarly zeroes the previously stored values (trim memory). This always applies to all flight modes.

Warning: The Autotrim feature, when active, always influences the model functions currently assigned to the particular trim buttons (except for throttle function which is never affected by this feature). The Autotrim function does not take effect on the auxiliary incremental trims. Please be very careful if you assign trim buttons to any function that is not controlled by a spring centered stick. It is advised to disable the Autotrim completely in such a case.

9.2.3 Flight Mode Trims

This menu allows you to set the function output position (if needed) for each flight mode individually. For example: if your elevator needs to be raised in one of your flight modes but not the others. Each function output can be set either globally or separately.

1. Servo Position

A transmitter output channel can be assigned to more than one receiver output channel if needed. Adjusting the values in the individual columns marked **"S1-S4"** will change the position of the servo (surface) for each output function. The servo position is displayed as a percentage of the total servo travel.

Pressing the **"F3 (Clr)"** button resets the highlighted line's travel values to 0%.

Pressing the **"F1 (Sym.)"** turns ON/OFF the lock which allows each output to be adjusted either together (symmetrically), or independently.

2. Trim Travel Global or Separate Setting

The servo trim position for each function output can be set either collectively for all flight modes by selecting the **“G-(globe symbol)”** or individually for each separate flight mode by selecting **“S-Separate”**.

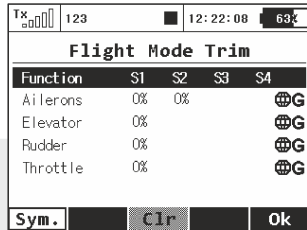

9.2.4 DualRate/Exponential

This menu allows you to set up dual or triple rates for any of your created output functions. Any of the channels can be set with dual/triple rates and custom exponential settings. Exponential settings can significantly increase your control precision by making your stick movements (around center point) yield less control movement. At the same time, the end points of the control surface throw can be set to its extremes.

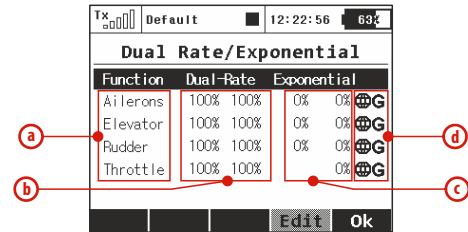

- a) Channel name
- b) Dual/Triple rate travel setting
- c) Exponential setting
- d) Global or separate flight mode setting

By highlighting one of the channels and either pressing the **“F4 (Edit)”** button or by pressing the **“3D Control”** button you will access the individual control’s settings page.

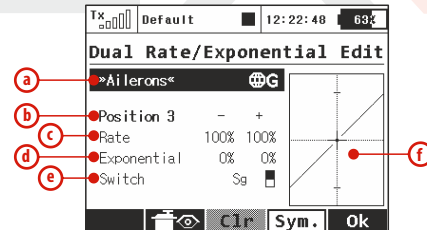

- a) Channel name and global/separate setting
- b) Current switch position

- c) Percentage of travel
- d) Exponential rate setting
- e) Assignable switch option
- f) Graphic interface

1. Expo Global or Separate Setting

Expo configuration for all channels can be set collectively for all flight modes by selecting the **“G-Global (globe)”** symbol or you can allow individual expo settings in each separate flight mode by selecting the **“S-Separate”** symbol.

2. Expo/Dual Rates Switch Assignment

By selecting **“Switch Option” (e)** you will access the **“Select Input Control”** screen where you can select the control element that you wish to control the dual rate and/or expo for the selected function. For simple dual rates, a 2-position switch is sufficient. For more complex triple-rates, any 3-position switch or one of the fully proportional channels can be selected. Then your selected switch is assigned. While the **“Select Input Control”** screen is still visible you can change the switch travel by using **“F2 (Prop.)”** button to select the proportional setting. The correct function can be verified in the **“Dual Rate Edit”** screen by activating the switch and observing the position number change to **“Position 1-2”** for a two position switch or, if 3-position switch is used, to **“Position 1-2-3”**. For a 3-position switch you will also need to use the **“F1 (Centr)”** button before all three positions are correctly displayed.

3. Expo/Dual Rates Travel Setting

Every switch position **(b)** can define a different function and exponential value. Any change made to the settings can be directly observed on graphic interface **(f)**.

Dual/Triple rate setting is defined by percentage of the travel **(c)**. A higher number increases travel, a lower number decreases travel.

Expo rate is defined by percentage of the function curve **(d)**. Zero rate represents linear function. As expo rate increases linear travel changes to exponential **“curve”** travel.

Exponential and Dual rate settings combined with flight modes create virtually unlimited customizability.

Advice: For smooth, precise flight we highly recommend setting up exponential and dual rates.

9.2.5 Programmable Function Curves

(*depending on equipment)

Function curves define the relationship between the actual position of your stick/switch/knob and the position of the servo. This screen displays the menu of all assigned functions (a), graphic interfaces (b), and programmable time delays (c). All adjustments can be visually inspected right away in the servo monitor page by pressing the "F2 (Servo)" button.

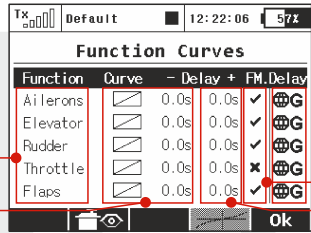

- a) Function name.
- b) Graphic interfaces.
- c) Time delay.
- d) Global or Separate setting.
- e) Flight Mode Delay Enable

Flight Mode Delay Enable

In the menu „*Fine Tuning->Function Curves*“, it is possible to activate/deactivate a delay for a specific function while switching between flight modes. Specifically, in the picture, it is the 5th column (FM. Delay) that allows this. The activation of a delay also might be flight-mode specific (i.e.: in the first flight mode the delay is

activated and in the second mode it is disabled). There are some specific conditions where setting this option for one function has an effect in another function.

- If V-Tail is selected, the option influences both rudder and elevator.
- If Delta wing is selected, the option influences both elevator and aileron.
- If electronic heli swash mix is selected, the option influences all functions of the swash plate (roll, pitch, and elevator).

1. Programming Function Curves

The Function Curves programming screen can be accessed by highlighting "Curve" window and pressing "3D Control" button or directly accessed by simply pressing "F4" button. Either way, you will be taken to the highlighted function's curve option screen.

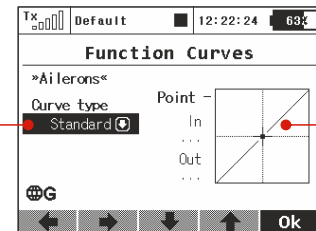

- a) Function curve type.
- b) Graphic interface.

The function curve can be selected from the existing list or from custom, previously modified options.

Available Options:

Standard	Linear values, set In/Out point
Constant	Constant value, set point
3-Point, $x > 0$, $x < 0$, $ x $	3-Point curve, set value for 3 points
5-Point	5-Point curve, set value for 5 points
7-Point	7-Point curve, set value for 7 points
9-Point	9-Point curve, set value for 9 points
+Pos, - neg, +-Symmetrical	4-Point end to end curve, set value for 4 points

2. Function Curve Setting

You can select the function curve which best fits your application. You can choose one of the pre-programmed 3-9 point ones or select any of custom symmetrical curves.

You can edit a function curve from inside the graphic interface by moving the displayed control points.

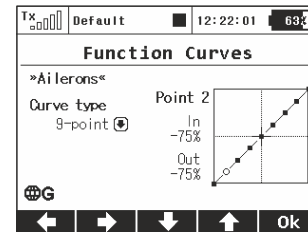

All of the points can be moved in both horizontal and vertical directions. Using the **"3D Control"** or the **"F3"** and **"F4"** buttons you can move the curve points in a vertical direction and in a horizontal direction by using the **"F1"** and **"F2"** buttons.

By pressing the **"3D Control"** button you can switch between the individual curve points. Pressing the **"Esc"** function will return you to the previous control point. On the left side of the graphic interface you will see the percentage representation of your selected control point's position. **"In"** and **"Out"** percentage numbers represent actual input and output position of a given control point.

3. Function Curve Delay

The time delay function can help smooth the transition from one state to another. The function of the **"Delay"** is to slow down the movement of a control surface in relationship to the position of the stick. Example: a negative number **"-"** slows movement of the rudder from moving right to left, a positive **"+"** number slows rudder movement from left to right.

4. Global or Separate Function Curve Setting

The function curve configuration for all channels can be set collectively for all flight modes by selecting the **“G-Global (globe)”** symbol or you can set individual function curve settings in each separate flight mode by selecting the **“S-Separate”** symbol.

9.2.6 Aileron Differential

The aileron differential function reduces the downward travel of the aileron(s) to help eliminate any adverse yaw tendencies in rolling maneuvers. Semi-Symmetrical airfoils with an aileron in the down position induce higher drag than when the aileron is in the up position. Therefore, the aileron travel up and down has to be set differently. The number of aileron servos displayed depends upon the selected wing type of your airplane; the maximum number is four **“S1-S4”**.

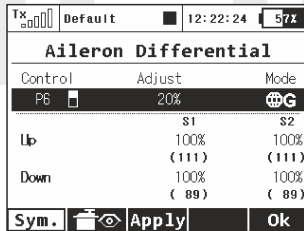

1. Aileron Differential Global or Separate Setting

The aileron differential for all channels can be set collectively for all flight modes by selecting the **“G-Global (globe)”** symbol or you can allow individual aileron differential settings in each separate flight mode by selecting the **“S-Separate”** symbol.

2. Aileron Differential Setting

All of the ailerons can have different travel ranges. The different adjustments are displayed in columns marked **„S1-S4”**. The number of servos in use is equal to the number of displayed setup columns. The travel range for each servo can be set. Scroll and highlight either the **“Up”** or **“Down”** menu line with **“3D Control”** button. Press the **„3D Control”** button to access and edit the settings for each servo. If the servos need to be adjusted independently, use the **“F1 (Sym.)”** button to unlock the servo travel for adjusting the individual values in the selected menu line.

3. Tuning of Aileron Differential

You can now assign a proportional control and the adjustment rate. When moving the control, the differential rates are updated accordingly: up-rate is increased and the down-rate is decreased depending on the adjustment rate and position of the control. In the picture the real differential rates are enclosed in parenthesis.

The **„F(3) Apply”** button clears the adjustment rate and stores the real differential values into the editable fields so that the control no longer has any influence.

9.2.7 Ailevator Function

The ailevator function uses two servos for the elevator channel. Both sides can be programmed to be controlled independently. With ailevator function both servos can be mixed together with ailerons and work in sync for better roll control. The Ailevator mix has to be activated by choosing the **“Ailevator2H1V”** tail setting. Unless you have previously chosen a different percentage for one of the tail mixes, the initial settings for **“Ailevator”** function are 100% of the elevator travel and 0% of the aileron travel.

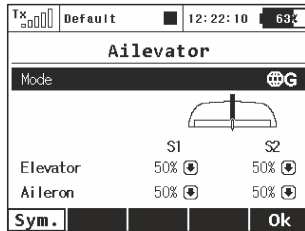

1. Ailevator Global or Separate Setting

The Ailevator configuration for both channels can be set collectively for all flight modes by selecting the **"G (globe)"** symbol or you can set individual Ailevator settings in each separate flight mode by selecting the **"S-Separate"** symbol.

2. Ailevator Setting

Ailevator configuration has four different adjustable parameters. The lines marked **"Elevator"** and **"Aileron"** contain two columns **"S1"** and **"S2"** which represent the elevator and aileron surface throws as a percentage. Scroll and highlight the lines marked as **"Elevator"** or **"Aileron"** with the **"3D Control"** button and press the **"3D Control"** button to access the individual setting of each servo. If the servos need to be adjusted independently, use the **"F1 (Sym.)"** button to unlock the servo travel for adjusting the individual values in the selected menu line.

9.2.8 V-Tail Mix

If your model is equipped with a V-Tail, The two basic tail functions (rudder and elevator) are mixed to control the tail of the airplane. The V-Tail mix has to be activated by choosing the **"V-Tail 2H"** tail setting. Unless you have previously chosen a different percentage for one of the tail mixes, the initial settings for **"V-Tail"** function are 50% of the rudder and elevator travels.

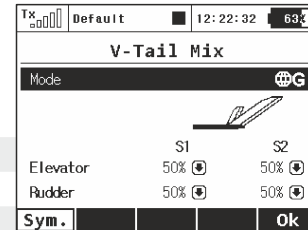

1. V-Tail Global or Separate Setting

The V-Tail configuration for both channels can be set collectively for all flight modes by selecting the **"G (globe)"** symbol or you can set individual V-Tail settings in each separate flight mode by selecting the **"S-Separate"** symbol.

2. V-Tail Setting

The V-Tail configuration has four different adjustable parameters. The lines marked **"Elevator"** and **"Rudder"** contain two columns **"S1"** and **"S2"** which represent the elevator and aileron surface throws as a percentage. Scroll and highlight the lines marked as **"Elevator"** or **"Rudder"** with the **"3D Control"** button and press the **"3D Control"** button to access the individual setting of each servo. If the servos need to be adjusted independently, use the **"F1 (Sym.)"** button to unlock the servo travel for adjusting the individual values in the selected menu line.

9.2.9 Delta/Elevon Mix

The Delta/Elevon Mix uses two servos for the control of both the elevator and aileron functions. This mix is most commonly used for Delta type aircraft. The elevon mix has to be activated by choosing the **“None – Elevon/Delta”** tail setting. Unless you have previously chosen a different percentage for one of the tail mixes, the default settings for the **“Delta/Elevon”** function are 50% of the aileron and elevator travels.

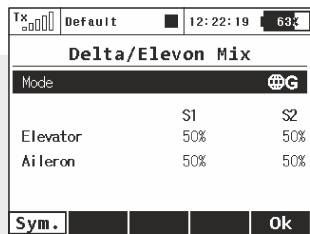

1. Delta/Elevon Global or Separate Setting

The Delta/Elevon configuration for both channels can be set collectively for all flight modes by selecting the **“G (globe)”** symbol or you can set individual Delta/Elevon settings in each separate flight mode by selecting the **“S-Separate”** symbol.

2. Delta/Elevon Setting

Delta/Elevon configuration has four different adjustable parameters. The lines marked **“Elevator”** and **“Aileron”** contain two columns **“S1”** and **“S2”** which represent the elevator and aileron surface throws as a percentage. Scroll and highlight the lines marked as **“Elevator”** or **“Aileron”** with the **“3D Control”** button and press the **“3D Control”** button to access the individual setting of

each servo. If the servos need to be adjusted independantly, use the **“F1 (Sym.)”** button to unlock the servo travel for adjusting the individual values in the selected menu line.

9.2.10 Butterfly Mix (Crow Mix)

The basic configuration of the butterfly mix (also known as crow) is created by using ailerons, flaps, and elevator flying surfaces. The Butterfly/Crow mix is helpful for maintaining speed during fast descends and creating controlled drag for spot landings.

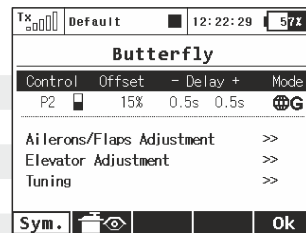

1. Butterfly/Crow Activation

The Butterfly mix can be activated by any control element (**Switch/Knob/Stick**). By selecting the switch and by editing the desired assignment you can activate and select the position at which this Switch/Knob/Stick or Logical Switch will turn the Butterfly mix ON or OFF. This menu line includes a visual graphic to show the ON or OFF position of your selected switch.

2. Butterfly/Crow Delay

The time delay function can help smooth the transition from one state to another. Function of the **“Delay”** is to slow down the

movement of the control surfaces during the change. Increasing the number on the positive side "+" slows the deployment while increasing the number on the negative side "-" slows return of the surfaces to their original positions.

3. Butterfly/Crow Global or Separate Setting

The Butterfly/Crow mix configuration settings can be set collectively for all flight modes by selecting the "G-(globe)" symbol or you can allow individual aileron differential settings in each separate flight mode by selecting the "S-Separate" symbol.

4. Butterfly/Offset

Due to the request of many sailplane pilots this function was updated. Now expanded to four screens, there are several added options in this menu.

a. You can set an offset to the butterfly control so that there will be a specified dead zone at the beginning of the control stick's travel.

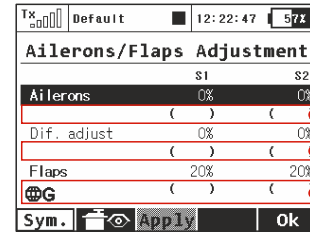

Actual values of airbrake rates. The values shown depend on adjustments made in Butterfly Tuning menu (see below).

b. Ailerons/Flaps Adjustment

In the Ailerons/Flaps Adjustment menu you can set all the travel needed for butterfly braking (for the flaps and ailerons). Also, you can set a parameter called Diff. adjust which influences the aileron differential. Positive values increase the upper travel of the aileron servos, negative values increase the lower travel of the aileron servos.

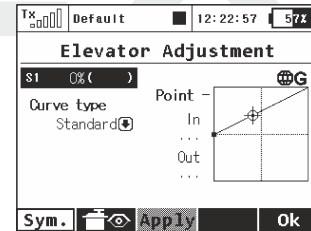

c. Elevator compensation

The butterfly mixing is always from zero to the full stick position so the curve is a little bit modified to control the whole travel range. You can choose between a standard curve, constant and X-point curve types.

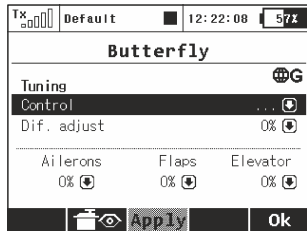

d. Butterfly Tuning menu

Screen of the Butterfly menu allows you to fine tune all braking travels through one proportional control (stick, knob or switch). The values you set in this screen are added/subtracted to the appropriate butterfly travels. The way these values influence servo deflections depends on the position of the butterfly's control stick and the position of the butterfly's Tuning control.

The „F3Apply“ button operates similarly as in the Aileron Differential menu. If you press this button, the values set in the „Butterfly Tuning“ menu are copied into the appropriate travels in the „Butterfly Ailerons/Flaps/Elevator Adjustment“ menu. After that, all values in the Butterfly Tuning menu are initially set to zero (so that the tuning control no longer has an effect).

9.2.11 Free Mixes (*depends on equipment)

The Free (programmable) mixes are used to make a second or „slave“ channel react as a result of the original channel's input or by moving any Switch, Knob or Stick. Any of the channels can be (Freely) mixed with any other function, assignment or logical switch. Up to 20 free mixes can be programmed for any given model. The primary channel („Master/From“) specifies the control or input function, while the channel that reacts to the Master is called the „Slave/To“ channel. The „Master Value“ represents the percentage of „slave“ channel travel output performed when the „Master“ channel function is used.

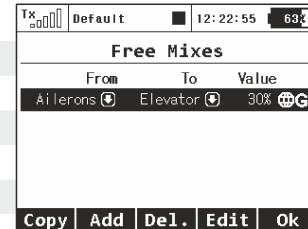

1. Copying a Free Mix

Highlight an existing free mix and use the „F1 (Copy)“ button to create a copy of the existing mix.

2. Creating a Free Mix

Use the „F2 (Add)“ button to create a new free mix. The Primary channel called „Master/From“ specifies the input function, while the channel that reacts to the Master is called the „Slave/To“ channel. The last variable on the screen is the „Master Value“ which represents the percentage of the slave channel's mix/travel. After your model's basic configuration is finished, use the „F5 (Next)“

button to exit the free mix screen. If you need to make any changes simply highlight the desired free mix and press the **“F4 (Edit)”** button to reach the advanced settings menu for that free mix.

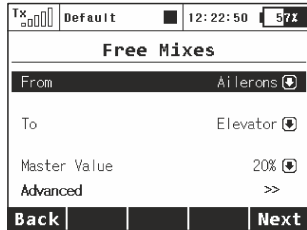

a). Free Mix Setting

The free mix configuration settings can be set collectively for all flight modes by selecting the **“G-(globe)”** symbol or you can allow individual free mix settings in each separate flight mode by selecting the **“S-Separate”** symbol.

b) Free Mix Activation

A free mix can be activated by any Switch/Knob/Stick. By selecting **“Switch”** and by editing the desired assignment you can activate and choose the position at which this Switch/Knob/Stick or Logical Switch will turn the mix ON or OFF or even **control its throw proportionally**. This menu line includes a visual graphic to show the ON or OFF position of your selected switch. If you do not select any switch, then the mix is always ON.

c) Free Mix Curve Programming

This programming screen can be accessed by highlighting the **“Curve”** item and by either using the **“3D Control”** button or by pressing the **“F4 (Curve)”** button. By accessing the **“Mixer Curve”** function screen you can select the mix curve which best fits your application.

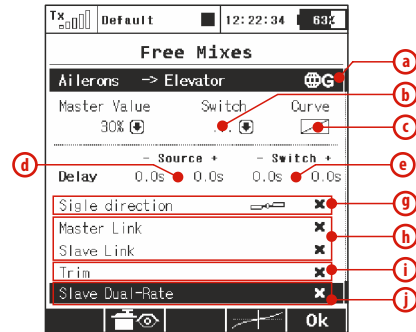

d) Free Mix Deployment Delay

The time delay function can help smooth the transition from one state to another. Values adjusted in the **“Source”** item will slow down full mix deployment when the mix is ON (switched ON or always ON) and the master channel changes its value. In this item, when you add a delay to only one side (- or +), the mix deployment will be slow in one direction only (**-100% to 100%**) or (**100% to -100%**). When you add a delay to both the negative (-) and the positive (+) sides, then your mix will be slowed in both throw directions.

e) Free Mix Activation/Deactivation Delay

The **„Switch”** values can only be when you have assigned a switch to turn the mix ON and OFF. This delay operates independently from the **„Source”** values. The positive side of a delay is applied if the mix is activated using Activation Switch. The negative side is used if the mix is deactivated and both slow down any fast reactions while turning the mix ON and OFF.

f) Free Mix Multiple Servo Settings

If the mix uses more than one output function as the slave, then the **“Output Mix”** menu will appear. This menu allows you to edit the settings for the individual slave servos (S1-S4).

g) Free Mix Directional Positive/Negative Movements

Once the free mix function is created you can edit the advanced settings menu so that the mix will either add to or reduce a slave function’s movement. To do this, you can set the mix value as a positive percentage or a negative percentage.

h) Using Another Free Mix to control a Free Mix

A free mix can be controlled by just a control input function (Master) or it can also be controlled by another free mix’s control function (Slave). Here is how to create a free mix whose input is controlled by an existing free mixer output:

- To allow a free mix to control another free mix you must enable the **“Slave Link”** option. This allows the free mix to act as input for other free mixes. Use the **“3D button”** to highlight and select this option. You will see a check mark if the option is enabled and an X if it is disabled. You will also use the (+) or (-) to determine the mix direction.
- To allow a free mix to be controlled by another mix you must enable the **“Master Link”** option. This allows the free mix to accept the input from other free mixes. Use the **“3D button”** to highlight and select this option. You will see a check mark if the option is enabled and an X if it is disabled. You will also use the (+) or (-) to determine the mix direction.

i) Free Mix Trim Settings

This item allows you to enable or disable whether trim functions will influence the free mix or not.

j) Free Mix Control by Dual Rates

With this item you can activate or deactivate the **“Slave Dual-Rate”** function for the free mix. This settings allows the slave output to be affected by dual rate inputs. All adjustments can be visually inspected right away in the servo monitor page by pressing the **“F2 (Servo)”** button. Pressing the **“F5 (Ok)”** button returns you back to free mix screen.

k) Aileron Differential

This option is displayed only after you create a mix from any function to Ailerons. When this option is activated, the output of the mix will be influenced by the aileron differential settings. If this option is deactivated, the output of the mix is transmitted directly to the servo without any modifications. Uncheck this option if you want to use aileron differential fine tuning without affecting throws of the mixes applied on ailerons.

3. Deleting a Free Mix

Press the **“F3 (Del)”** button to delete the highlighted free mix.

4. Configuration & Setting

A free mix programming screen can be accessed by highlighting the selected mix and then pressing the **“F4 (Edit)”** button.

9.2.12 Governor/Gyro (*depends on equipment)

Typically, a gyro is used to stabilize a model helicopter along its vertical axis (rudder). One channel is reserved so that you may adjust the gyro sensitivity (gain) from the transmitter. Also, a separate channel can be reserved for the control of a throttle governor. The governor can be enabled when you create the model or later from the „**Model >Basic Properties**“ menu. This menu allows you to adjust the settings for both of these output channels. The Governor/Gyro settings can be set collectively for all flight modes by selecting the **“G-globe”** symbol or you can allow individual Governor/Gyro settings in each separate flight mode by selecting the **“S-Separate”** symbol.

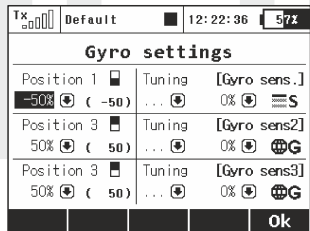

1. Gyro Settings

By default, the gyro sensitivity is assigned to the three position „**Si**“ switch. This allows you to have three different settings (Position 1, Position 2, Position 3) for the gyro sensitivity. You can always assign this function to a different transmitter control element (knob, slider, switch) in the „**Model, >Function Assignment**“ menu. The Gyro settings can be set collectively for all flight modes by selecting the **“G-globe”** symbol or you can allow individual Gyro settings in each separate flight mode by selecting the **“S-Separate”** symbol.

In the Gyro settings menu it is possible to edit up to three main values for each gyro function in all flight modes separately according to the position of the **main control/switch**.

Moving the switch to the selected position causes an automatic update of the depicted values in the appropriate line. Set the main value of the gyro gain to the needed value (highlighted in the picture), eventually also assign an appropriate control for fine tuning – here it is necessary to set also the percentage range of the control influence. For each position of the main control it is possible to individually assign an independent control for fine tuning of the gyro gain. The resulting applied gain value is displayed in parentheses (-50% in this case).

Note: *Negative values of gyro gain indicate the gain in "Normal" mode, positive values indicate the gain in the "Heading-lock" mode.*

2. Governor Settings

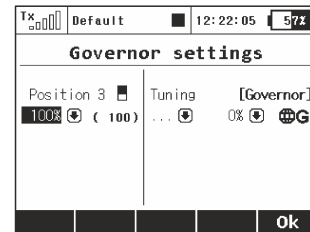

If you have the governor function enabled, by default, the governor sensitivity is assigned to the three position „**Sg**“ switch. This allows

you to have three different settings (Position 1, Position 2, Position 3) for the governor sensitivity. You can always assign this function to a different transmitter control element (knob, slider, switch) in the „**Model**, >**Function Assignment**“ menu. The governor settings can be set collectively for all flight modes by selecting the “**G-globe**” symbol or you can allow individual governor settings in each separate flight mode by selecting the “**S-Separate**” symbol.

Like in Gyro gain settings, it is also possible to select up to three main values for governor RPM control in the Governor settings menu (0% means zero RPM, 100% means full throttle). It is also possible to assign a specific control to each governor position (switch, stick or knob), which can precisely tune required RPM – in this case it is necessary also to specify the range of the influence of the tuning control to the RPM. The resulting applied value of the Governor function is displayed in the parentheses. The setting can be global for all flight modes or separate for each mode.

9.2.13 Throttle Limiter (*depending on equipment)

If you have several flight modes and all of them have specific throttle curves, the Throttle Limiter might help you to get the motor's RPM safely from the lowest to the maximum RPM that is controlled by your throttle curve.

You are free to choose any control device (proportional or a switch) that will operate as a speed limiter. It doesn't allow the throttle to go any higher than the position that this control shows. The limiter

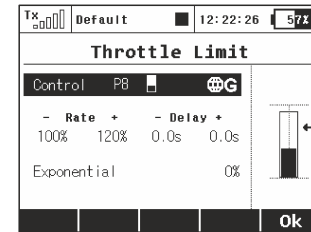

operates within a specified range (negative and positive rate, “- **Rate** +”). Using the “-” rate you can set the lowest motor RPM you want to use. This is the point where the limiter begins its operation. The “+” rate represents the maximum possible output of your throttle channel. If your application needs full throttle, you should set the “+” rate to a value higher than 100% so that the full throttle output is not limited.

It is possible to set some delay for this control (if it is assigned to a switch) so that the motor goes smoothly from low to high RPM (and vice versa). Finally, the Exponential parameter enables you to fine-tune the output at lower RPM and the whole acceleration curve.

The throttle limiter also influences mixes where the throttle acts as the source. The trim function is not influenced by the throttle limiter. If a control device is not assigned, the throttle limiter function is disabled.

9.2.14 Snap Roll

The snap roll function is intended for aerobatic pilots who want an instant stunt controlled by a single switch. There are two modes of the snap roll function:

Tx		Default		12:22:51		97%	
Snap Roll							
Mode	Master	Switch	Sa	x	⊕	⊖	G
		↑/→	↓/→	↑/←	↓/←		
Ailerons	100%	100%	-100%	-100%			
Elevator	-100%	100%	-100%	100%			
Rudder	100%	-100%	-100%	100%			
Switch	Sb	x	Sb	x	Sb	✓	... (G)
Delay +	0.0s	0.0s	0.0s	0.0s	0.0s	0.0s	
Delay -	0.0s	0.0s	0.0s	0.0s	0.0s	0.0s	

Separate switches for every direction. The priority goes from up/right direction (highest) and continues until down/left (lowest).

- 1. Master mode** – the stunt itself is done by activating a master switch (Sa in this case). The other switches are taking care of the direction of the stunt.
- 2. Single mode** – the stunt is done immediately after any direction switch is activated.

You may enter your desired properties for ailerons, elevator and rudder separately for every direction. There are four directions available (up/right, down/right, up/left and down/left), each one is controlled by a separate direction switch. Each element may store its own fade-in/fade-out ramp which is defined by the rows **“Delay +”** and **“Delay -”**.

All options may be either flight-mode-specific or global. You can see the current state of the snap roll function in the bottom left corner of the display.

Note: This function is not available for helicopters, v-tails or delta wings.



9.3 Advanced Properties

Advanced programming menu for DC/DS. (*depends on equipment)

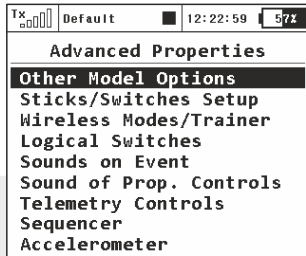

9.3.1 Other Model Options

This menu contains additional, special features of the DC/DS transmitters.

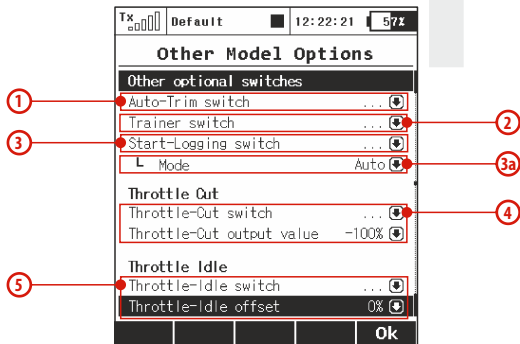

1. Auto-Trim Function

Auto-Trim function can be activated using any assigned switch, knob or stick. Once this function has been activated you can trim your model using transmitter gimbals. The direction and speed of the trim adjustment is determined by stick movement. Larger stick movements equal a faster trim response. When the Auto-Trim function is active, the transmitter gimbals do not change their standard response. The transmitter is still in normal operation mode.

Advice: It is advised to use the automatic trim function only for the maiden flight, after proper trimming is done we recommend disabling this function.

2. Trainer Function

The Trainer function can be set so that it may be activated using any assigned switch, knob or stick.

3. Telemetry Recording

The Telemetry recording function can be set so that it may be activated using any assigned switch, knob or stick. The data stream is recorded on the internal SD memory card. All data can be found in the "Log" directory of the transmitter software after connecting the Tx to the PC via a USB port. Active data recording is indicated on the upper edge of the main desktop screen by a blinking circle. A solid square graphic indicates that recording is stopped.

3a. Mode

By default ("Auto" mode), the telemetry starts recording after any timer is activated, Start-logging switch is flipped or Start button on the main screen is pressed. If the "Start/Stop" mode is selected, the status of recording is always controlled by the position of your selected Start-logging switch.

4. Throttle Cut Setting

This safety feature is mainly for models using glow or gasoline engines as their main source of power. Electric models can also highly benefit from this safety feature. The Throttle Cut function can be activated using any assigned switch, knob or stick. By editing the "Output Value" item, the throttle output will move to the user defined (completely off) throttle position once the assigned switch is activated.

5. Throttle Idle Setting

This feature is used to set the idle position for your throttle and will prevent your engine from shutting-off when you move throttle stick to its low position. The minimum throttle setting is defined by editing the "Idle Offset" value. When this function has been activated, the minimum throttle setting (idle point) is defined by the offset value as a percentage. Standard throttle function is not affected by the idle offset setting.

9.3.2 Sticks / Switches Setup

This menu contains System Stick/Switch settings and configuration. Various functions can be activated by any Switch, Stick or Knob position. Switch setting enables you to set the points when your desired function/timer/telemetry can be turned ON or OFF.

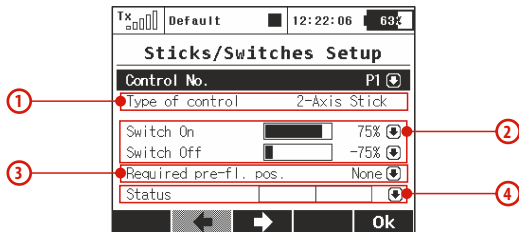

1. Switch & Stick Type

The first menu line item lists the control's number and the second item lists the type of control element. Using the "F2" and "F3" function buttons you can scroll through channels, with the "F5 (Ok)" button you can exit the menu screen.

By default, the switch types are always automatically detected, however, it is also possible to overwrite any of the auto-detected switch types with a user-defined type. The choices are: "Auto" which keeps the auto-detection running, "None" that disables the particular input control, standard "Std. Switch", "3-Pos. Switch", "Button" and "Proportional". Any value other than Auto will disable auto-detection for the specified control. Remember, these settings are global and are applied to all models. The only model-specific "Type of control" property applies to stick-switches **Sk** and **Sl**. This feature is useful, for example, if you want to have a standard switch that behaves like a spring loaded switch equipped with button memory.

2. Switch ON/OFF Points

Any proportional function can be set as a system switch. This menu item enables you to assign the travel percentage at which a desired function can be turned ON or OFF.

"Switch-ON" – The point when the control element position will switch a function ON.

"Switch-OFF" – The point when the control element position will switch a function OFF.

By default, the system setting for all proportional channels and for all inputs is set to function the same as a 3-position switch.

a) A function above this point is considered to be "Switch ON"

b) A function in this range (middle) can be considered to be either **“Switch ON”** or **“Switch OFF”**

c) A Function below this point is considered to be **“Switch OFF”**
If the switch setting is set at same level for **“Switch ON”** and **“Switch OFF”**, the proportional channel/function output will be the same as a 2-position switch.

3. Required Preflight Position

For any functions assigned to the Switch, Knob or Stick, any preflight initial position can be programmed. If the pre-programmed Switches, Knobs or Sticks are not in required preflight position while model is being activated, system will refuse to switch to this model. The transmitter screen will display the function that is not in pre-programmed, correct preflight position.

4. Function Status Display

Position and status of the control is displayed in the status bar. On the right side of this menu you can see the status of the switch function as an “x” or checkmark.

1) Setting Example

If you have installed the optional a button/switch in your left or right stick, scroll thru the Control No. Menu line and pick the function switch **“Sk”** or **“Sl”** if the button switch is installed in your right stick.

Pick one of the **“Type of Control”** switch options:

- “2-Position Switch”
- “3-Position Switch”
- “Button”

For any functions assigned to the chosen switch, knob or stick, any preflight initial position can be programmed.

9.3.3 Wireless Modes/Trainer (*depends on equipment)

The transmitter RF modules can operate in one of three modes. For a detailed explanation. (see section 5) The wireless RF setting is programmed to the memory of individual models (receivers). While programming a selected model you will need to configure the RF module settings. The only exception for the system is the “Trainer” mode. If the particular model has been programmed in Trainer mode, this setting will not change if the Tx is turned ON or OFF.

For safety reasons, the **“Trainer”** RF mode will be switched automatically to **“Initial”** RF mode when a different model is selected in the transmitter.

DS/DC radio systems are excellent tools for instructor pilots. Basic training for a student is not different from flying his own model. Both the instructor and student have their own JETI transmitters, all communication between the transmitters is done wirelessly. The instructor decides when to give control of the model to the student and when it's time to step in. The instructor's primary transmitter RF module communicates with model and the secondary RF module communicates with student's transmitter. The Student's transmitter, if set to **“Student”** mode, disables its secondary RF module and uses only the primary RF module to communicate with instructor's transmitter.

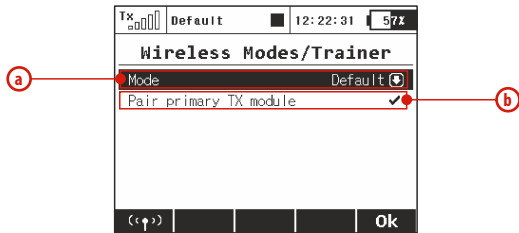

“Default” Wireless Mode

- a. Selection
- b. Primary RF module bind control menu line

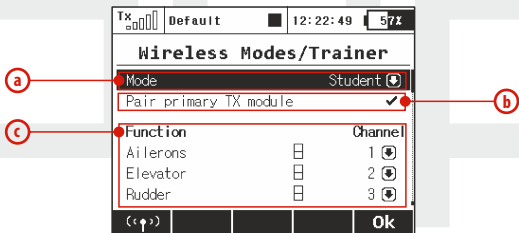

“Student” Wireless Mode

If student’s transmitter is set to “Student” mode, any dual-rates, mixes or any other advanced features are disabled in the student’s transmitter.

- a) Mode Selection.
- b) Binding initialization of the Instructor transmitter’s primary RF module or special wireless “Trainer” module by JETI.
- c) Channel function assignment.

“Instructor” Wireless Mode (* depending on equipment)

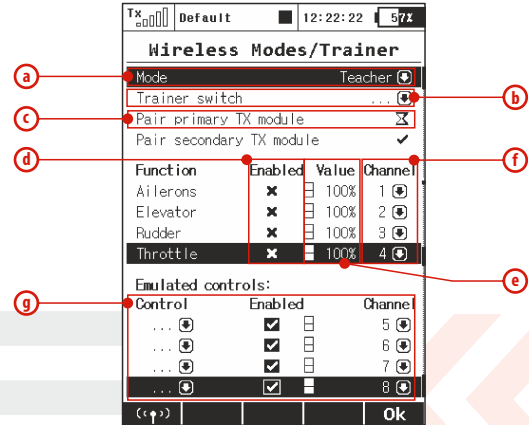

- a) Mode Selection.
- b) Assigned trainer function switch, when the switch is activated, control of the model is transferred to the student.
- c) Binding initialization of the Instructor transmitter’s secondary RF module with student’s transmitter.
- d) Channel function assignment. Some or all of the functions can be controlled by student.
- e) Instructor/Student control authority values. This setting limits the amount of control for the student. If the instructor is assigned a 60% control value to a particular channel, and student is assigned only a 40% value. The instructor can easily override student’s input and correct the model’s flight.

- f) Assignment for the input channel from the student's transmitter to the Control function of the instructor's transmitter.
- g) The Trainer Mode allows you to directly assign an arbitrary control (switch, stick, even a logical switch) which will be emulated for further use in the student's or teacher's transmitter. The list of emulated inputs is located at the bottom of the Function list. The behaviour depends on the mode setting of transmitter:

1) **Student mode.** Here you can simply assign an arbitrary control which will directly output its position/value to a defined channel of the student's transmitter. In the picture, the proportional control P8 is assigned to the seventh channel. You can disable the output by un-checking the "Enabled" button.

2) **Teacher mode.** Here you can decide which controls will be emulated by any of the student's channels. At the moment the student takes control of the model, the values of these controls are fully overwritten by the values of the appropriate student's channel. In the picture you can see that channel seven emulates the proportional control P8 and thus all functions that rely on this control knob. With this option, the student may switch the flight modes, operate the Butterfly function directly etc.

Disable RF Transmission

You can manually disable the wireless transmission by pressing the „F1 button“ followed by a confirmation of the choice. The RF system turns Off automatically when the USB connection is activated.



Caution: If you disable the transmission with a model attached, you may cause a signal loss alarm.

Trainer Mode with two JETI DS/DC Radios

1. Make sure that the instructor's transmitter is bound to the aircraft in the "Default" wireless mode and that all flying surfaces are functioning properly.
2. Change the instructor's transmitter wireless mode to "Teacher" and authorize the secondary TX module to bind with the student's transmitter.
3. Switch ON the student's transmitter, change its wireless mode to "Student" and allow the instructor's transmitter to bind properly. Verify that all of the aircraft's surfaces are correctly controlled by the student's transmitter. If they are not correct, make the necessary changes in the student's transmitter.

Trainer Mode for JETI DS/DC as the Instructor Radio

Other brands of transmitters can be used by the student with a JETI Duplex EX 2.4GHz radio system by using a special wireless "Trainer" communication module by JETI.

1. Make sure that the instructor's transmitter is bound to the aircraft in the **"Default"** wireless mode and that all flying surfaces are functioning properly.
2. Change the instructor's transmitter wireless mode to **"Teacher"** and authorize the secondary TX module to bind with the student's transmitter.
3. Connect the wireless trainer module to the student Tx **"Trainer Jack"** (see Tx manual), then prepare the module for binding to the instructor Tx by inserting the bind plug into the **"Ext"** port (see the module guide).
4. Verify that all of the aircraft's surfaces are correctly controlled by the student's transmitter. If they are not correct, make the necessary changes in the student's transmitter.

Double Path Wireless Mode (*depends on equipment)

- a) Mode Selection.
- b) Primary RF module bind control menu line
- c) Secondary RF module bind control menu line
- d) Optional signal loss alarm settings.

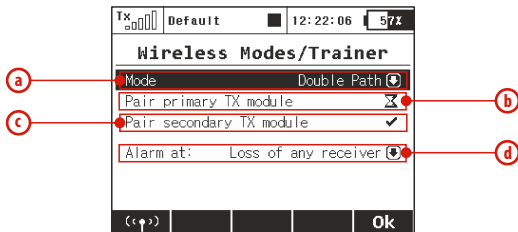

Signal Loss Alarm Settings

It is possible to define a specific response from the transmitter after one or more receivers disconnect or lose signal. The options are:

- **Loss of any receiver** – the alarm is activated every time any of the receivers loses a connection. This mode is sufficient for applications where two receivers control separate functions of the model. Both receivers must be connected for proper function.
- **Loss of receiver Rx1** – an alarm is triggered only if the primary Rx loses connection. This mode is intended for competition pilots who use the primary Rx in the model while the second receiver is acting as a reference for the judges. In this mode, the receivers are independent and you can control your model with only one receiver connected.
- **Loss of receiver Rx2** – an alarm is triggered only if the secondary Rx loses connection. The intended use and behaviour of this mode is similar to the previous mode.
- **Loss of both receivers** – an alarm is triggered after the signal from both receivers is lost. You should use this option if you want to join servo signals redundantly using the Enlink plug or any other central control unit. Both receivers must be connected for proper function.

Pairing the transmitter with receivers in Double Path mode

1. Make sure that receivers are set in **Normal** mode, not in **Clone** mode.
2. Note down which receiver is the first and which is the second because of later easier identification. Keep the receivers switched off.
3. Switch on the transmitter with created model, in „**Advanced properties - Wireless modes/Trainer**“ menu item select „**Double Path mode**“.
4. Plug the **BIND PLUG** interconnection into **EXT** output of the first receiver. Switch on the receiver. Now the receiver expects a sequence for pairing (in case you have **Rx firmware version 3.11** and newer, this period is limited up to 60s).
5. Press „**3D pushbutton**“ on the transmitter over **"Pair primary TX module"** command. As soon as the receiver is identified, you will be asked for confirmation – now push OK button. Switch off the receiver and remove pairing interconnection.
6. Plug the **BIND PLUG** interconnection into **EXT** output of the second receiver. Switch on the receiver.
7. Press „**3D pushbutton**“ on the transmitter over **"Pair secondary TX module"** command. As soon as the receiver is identified, you will be asked for confirmation – now push OK button. Switch off the receiver and remove pairing interconnection.
8. Switch on both receivers. The connection should be established immediately, eventually servo control is allowed.
9. Now you can specify additional parameters of the Double Path mode so that the transmitter correctly responds to the signal loss from any of the receivers.



9.3.4 Logical Switches (*depending on equipment)

If you want to have single or multiple transmitter functions which are controlled based upon the condition of other control conditions, then setting up a logical switch is the way to go. Each logical switch is defined by a logical expression. The logical expression contains a logical function and the relationship of the other conditions which must exist for the logical function to be activated. The end result is that your logical switch can either work like a 2-position switch (ON/OFF) or like a proportional 3-position switch (ON/Center/OFF).

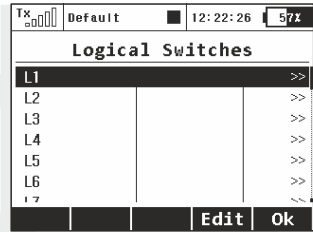

1. Creating a Logical Switch

Up to 16 independent logical switches can be created. Select one of the numbered lines and press the „3D button“ to access the logic switch setup menu. To enable the switch highlight and change the enabled value to **“Yes”**. Once activated you can see the control inputs and conditions on the menu screen. First set the control inputs #1 and #2 by assigning functions to switches, sticks or knobs. After that, select your desired logic statement (OR, YES, Multi). On the bottom of the screen the result of your logical expression is displayed by either a check mark or an **“X”**, depending upon the current condition state.

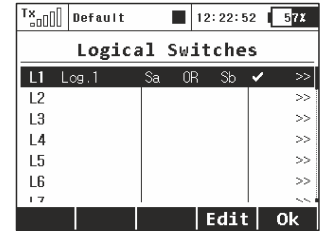
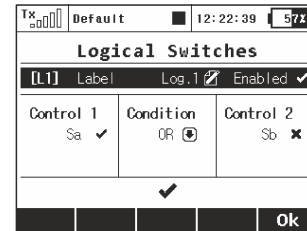

2. Logical Switch Proportion Calculation

Logical rules can also be created when your logical switch uses proportional channels. To enable proportional evaluation press the **„F2(Prop)“** button when you select your input controls. When you allow the use of proportional controls, an additional condition menu will appear. In this menu the conditions can be set by percentage value of the channel as well as by the value from which the switch will be in its full **ON/OFF** position. Those conditions will then be used to calculate the logical result.

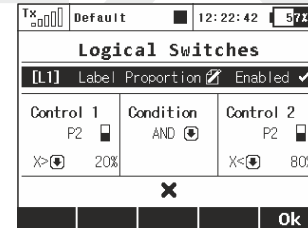

Example: This figure shows the use of proportional processing by a logical switch. In this example, if the P2 stick is moved between 20% and 80% of its travel, the logical switch is in the ON position. If the P2 stick is moved from 0% to 20% or from 80% to 100% then, the logical switch is in the OFF position. All 16 logical switches can be configured this way if needed. (number of available logical switches depends on actual transmitter equipment)

3. Emulating a 3-Position Switch

You can use the logic function **“Multi”** to allow the logic switch to act as a 3-position switch. The **“Multi”** logic function can combine the output from two 2-position switches to create a logic switch with three output conditions.

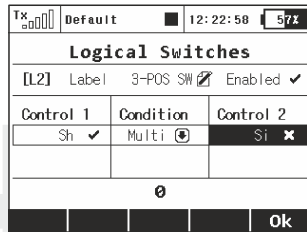

Switch 1	Switch 2	The result of the operator		
		AND	OR	Multi
<input checked="" type="checkbox"/>	<input checked="" type="checkbox"/>	<input checked="" type="checkbox"/>	<input checked="" type="checkbox"/>	<input checked="" type="checkbox"/>
<input checked="" type="checkbox"/>	<input checked="" type="checkbox"/>	<input checked="" type="checkbox"/>	<input checked="" type="checkbox"/>	<input type="checkbox"/>
<input checked="" type="checkbox"/>	<input checked="" type="checkbox"/>	<input checked="" type="checkbox"/>	<input checked="" type="checkbox"/>	<input type="checkbox"/>
<input checked="" type="checkbox"/>	<input checked="" type="checkbox"/>	<input checked="" type="checkbox"/>	<input checked="" type="checkbox"/>	<input checked="" type="checkbox"/>

4. Using Proportional Logical Switches

The logical switches also offer the option of a complete proportional evaluation that could be applied to both controls. Just select an input stick/slider, press the **F2 “Prop.”** button in the same menu (picture e)) and confirm. Then edit the selection box with options **“X<”, “X>”, “Lin”** and make sure that you select the **“Lin”** option (picture c)). At this point, the logical switch starts to act as a proportional control.

You can combine more controls using logical conditions:

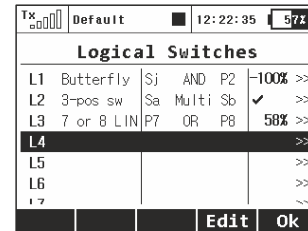

a)

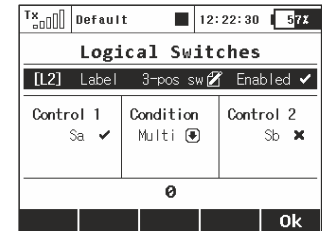

b)

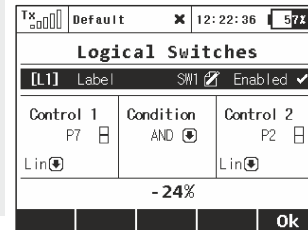

c)

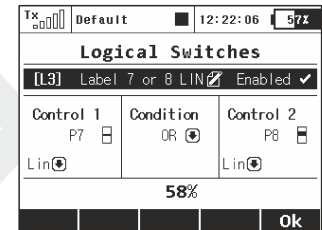

d)

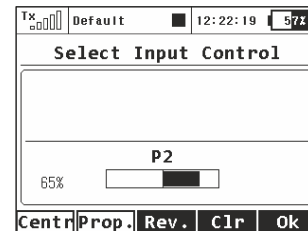

e)

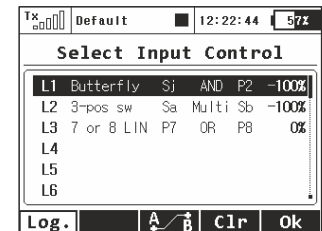

f)

- **The AND condition:** The resulting value of the switch is calculated as minimum value from both controls. If you have two sliders, the first one has +25% and the second one has -25%, the result returned by the logical switch will then be -25% (**picture c**).
- **The OR Condition:** The resulting value of the logical switch is calculated as maximum value from both controls. The higher value will be returned (**picture d**).
- **The Multi condition:** This option still emulates a 3-position switch. The output values of the logical switch are then in range - 100%, 0% and 100% (**picture b**).

Example: How to enable or disable the Butterfly function using a switch.

Many people want to have the ability to turn the Butterfly function on and off independently from any flight mode. So here we show the way to do that (**see picture c**).

1. Select an arbitrary switch as **Control 1**. In the picture, **Sj** was chosen. This switch will overwrite the function of **Control 2**.
2. As a **Control 2** select a proportional unit that will operate the Butterfly function (**P2** in this example). Make sure it is evaluated proportionally (**see picture e**).
3. **Control 1** and **Control 2** are linked together using AND logical function. That means, if the switch **Sj** is deactivated, the operation of **P2** will be blocked. Otherwise, **P2** will function normally.
4. In menu **Fine Tuning -> Butterfly** assign the newly created switch **L1** in the standard way and try its operation.

9.3.5 Sounds on Event (Sound Assignments)

(* depending on equipment)

You can assign an audio file to be played based on any transmitter condition. This means that any music file stored in the transmitter can be assigned to any switch, stick, knob, logical switch, alarm or any other special function. Since you can also upload music files the the DC/DS, you can fully customize how your transmitter communicates with you. If multiple sound files are triggered at the same time, they will play at the same time and their sounds will overlay each other.



1. Sound Switch Assignment

Select the "Switch" menu item and assign the switch that you want to use to trigger the sound playback.

2. Select the Sound File

Select the "File" menu item and select the sound file that you want assigned to the switch. The available audio files are stored in Directory/Audio. This is important to remember if you upload your own files.

3. Sound Playback Delay

The playback of any sound, after activation, can be delayed by editing the "Delay" menu item.

4. Sound Repeat

This menu item allows you to repeatedly play any sound after it has been activated. This can be useful if your selected sound's playing time is short.

9.3.6 Sequencer (*depending on equipment)

While this function can be used for direct control of landing gear servos, its usage is almost limitless. Two independent sequences might be used when you turn the source switch on and off.

You can define up to 6 sequencers **Q1-Q6** and within each sequencer you can define up to 16 control points for each path. Switching between different sequencers is possible by pressing the „F1 Down“ and „F2 Up“ buttons.

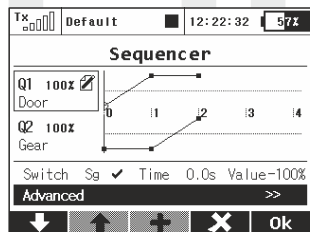

a)

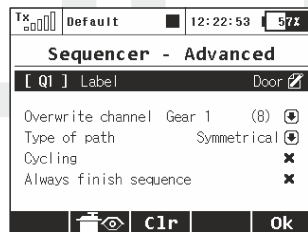

b)

To make a sequencer active, you should do the following steps:

1. Assign a source switch. In the **picture a)**, the **Sg** was selected. After this switch is activated, sequencer starts running. But first it has to know a path that consists of control points which are distributed over a period of time.

2. To add control points, you should move the timeline (edit **“Time”** column) so that it reaches the desired time. Then press the **„F3 Add”** button. The newly created control point will be highlighted and you can change its value (edit the **“Value”** column). Generally said, the point located closest to the timeline is highlighted and made editable.

3. You cannot move the control points in a time domain but you are able to delete any point by pressing **„F4 Delete”** button.

4. Now, when you activate the source switch, the timeline begins moving and the output of the sequencer is updated accordingly. If you deactivate (turn off) the switch, the sequencer moves in the opposite way.

There are some additional options that you can now set in the Advanced menu:

- You can label the sequencer to simplify identification.
- The option to overwrite a specific channel. *Example:* If you have several gear servos installed in your model, here is where you can define which servo will be directly controlled by the sequencer. Any other operations (like mixing or DR/Expo) will not be applied to the output.
- **Type of path (Symmetrical / Asymmetrical)** – this option tells the sequencer that there is either one symmetrical path, or there are two independent paths – one path is used after you activate the switch and another one after the switch is turned off. If you choose the Asymmetrical option, the sequence will always start from the very beginning and it doesn't matter whether the previous sequence is completed or not. It is recommended to use this option in conjunction with the Always finish sequence option.

- **Cycling** – if you wish a cyclic behaviour for your beacons, turrets or radar assemblies just check this option.
- **Always finish sequence** – After checking this option, the sequencer will never be interrupted and always will travel from the beginning to the end of its path.
- The „F3 Clr” button clears all data from the sequencer and resets it to the default state.

9.3.7 Accelerometer (DS only) (*depending on equipment)

The DS is equipped with an inertial unit that allows you to precisely determine the orientation of the device in space. This unit consists of a 3-axis gyroscope, 3-axis accelerometer and additional mathematic operations. You can freely use this inertial unit to control any function, trigger any voice announcements or you can simply flip pages on the main screen.

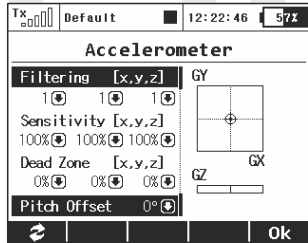

a)

You can configure some of the inertial unit parameters in **Advanced Properties -> Accelerometer**. In the **picture a)**, the actual orientation of the transmitter is displayed. The axes GX, GY, GZ are defined as *roll*, *pitch* and *yaw* in the same order. The graph shows the final values after all corrections have been made.

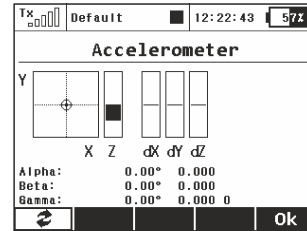

b)

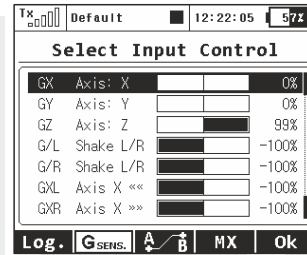

c)

Within this menu, you can edit following parameters:

Filtering – This increases smoothness of the movement for each axis separately. You can set values in range from 0 to 10. Zero value means no filtering and gives fast reactions. The higher the filtering setting, the movement becomes slower and smoother.

Sensitivity – This influences the gain of the inertial unit for each axis separately. If you feel that the reactions of the controlled function are too small for the particular movement, you can simply increase the corresponding value of sensitivity, numerically up to 400%.

Dead Zone – This means that as the value is increased, the more you can move the transmitter around the middle position and the output of the inertial unit will remain zero.

Pitch Offset – This shifts the **GY axis** so that you don't have to hold or keep the transmitter in a completely horizontal position all the time.

You can also view the raw data coming from accelerometer and gyroscope by pressing the „F1 button” (see **picture b)**). This might help you to fine tune your setup.

After you have finished setting the inertial unit itself, you can assign the resulting variables to any function using a standard input dialog (picture c). To see the variables of the inertial unit, you have to press the „F2 Gsens.“ button. The axes GX, GY, GZ correspond to the graph shown in the picture a). The last parameters are called Shake L/R and represent a motion gesture. If you quickly shift the transmitter to the left, the G/L switch will be activated for a short time. Similarly, a single movement to the right activates the G/R switch. You can use these gestures to trigger voice announcements, flip pages of the main screen etc.

The parameters "Axis X<<" and "Axis X>>" represent virtual two-state switches which are activated when the transmitter is tilted to the left or to the right along the X-axis.

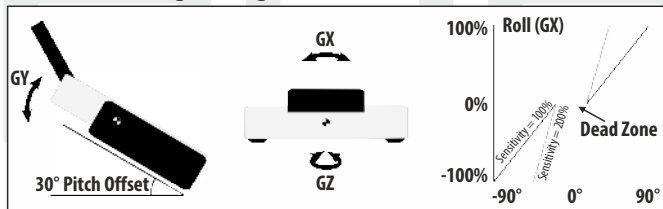

9.3.8 Telemetry Controls (*depends on equipment)

Not only can you display telemetry data, record it to your SD card or have it voice announced, now it is possible to control specific model functions using sensor inputs. This way, some tasks that previously required manual adjustment via visual estimation or alarms can now be automated.

Up to 8 controls labeled **MX1 – MX8** are available, depending on the type of transmitter and equipment. Telemetry controls offer functionality in two modes:

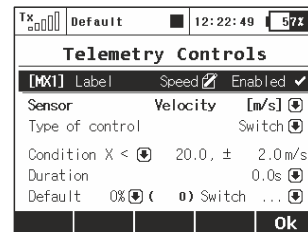
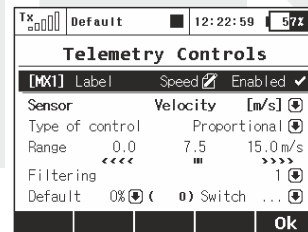
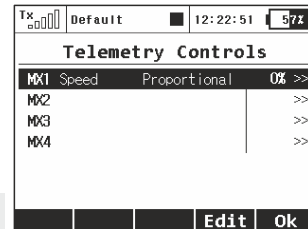

- The Switch mode enables you to create a virtual two-position switch using the value of one telemetry parameter. This switch is always active based on the fulfillment of defined logical conditions.
- The Proportional Control mode enables you to transform a certain range of sensor values into a fully proportional control. It can automatically and smoothly control any kind of function using telemetry feedback.

Examples for the possible use of telemetry controls

- If the model speed is less than X m/s, flaps will be raised automatically.
- If the current is larger than X amperes, the motor run timer starts.
- If the motor temperature is higher than 80 °C, the maximum throttle will be limited by the mix.

- If the on-state of the limit switch is detected, the sequencer automatically starts. (eg after opening the landing gear doors, the main gear will be deployed).

Setting the parameters of telemetry controls

Description – Sensor name that will be displayed in the list for easier orientation.

Active – Tick to enable the telemetry control function.

Sensor – Here you can select a specific telemetry parameter.

Type of control – Select Switch or Proportional control according to the required functionality.

Condition (X<, X>, X=) – Select the condition under which you want the control to be active (ie switched on). In the same line, fill in the numerical value of the decision levels and the hysteresis value (prefixed with ±). Available in Switch mode.

- **Example 1:** The entry “X < 20.0m/s ± 2.0m/s” means that telemetry control switches precisely when the telemetry parameter value is less than 18 m/s (due to hysteresis of 2 m/s). The control then symmetrically switches off when the speed exceeds 22 m/s.
- **Example 2:** The entry “X > 0 ± 0” indicates a switch that is activated whenever the telemetry value is positive.

Duration – minimum time of being switched on. If an event takes a very short time, it is possible to extend the time of the telemetry control being switched on for the time specified by this parameter. Available in the Switch mode.

Range – Set the operating range of the sensor (minimum value, center value, and maximum value). This level will then be transformed into a proportional range of the control (-100%, 0%, 100%). Available in Proportional control mode.

Filtering – Determines the level of received telemetry values smoothing (filtering). The higher the level of filtration, the smoother the course, but the response will be slower. Available in Proportional control mode.

Default – The default control value, if the sensor is not present in the model or the model is not turned on.

Switch – This parameter can specify any switch, which will activate or deactivate the operation of the telemetry control.

9.3.9 Sound of Proportional Controls

In this menu, you can set a sound notification for up to four independent controls. You can choose a basic beep in the middle control position (Center-Beep mode), but voice announcements of the current position is also available (Voice mode).

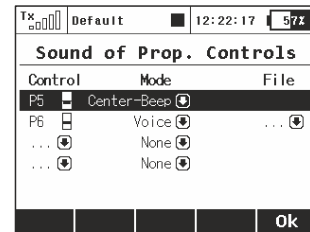

- Center-Beep mode – the transmitter beeps whenever the control goes to a central position (its deflection is thus 0%).
- Voice mode – the transmitter will vocally announce the numeric value of the current position of the control. The value is reported after every change of the control position and only after the movement is stopped. In this mode, you can also select an audio file that will alert you when changes in control positions are detected.

Example: If you generate the “**CONTROL.WAV**” file and then assign it as the File parameter, the transmitter announces eg “**Control: twenty-five**”.

The setting is always valid for the current model.

9.4 Timers/Sensors

-Set up of Timers and Telemetry Sensors (*depends on equipment)

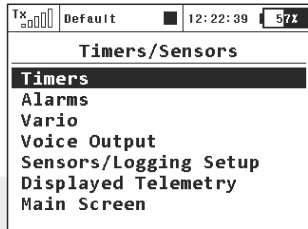

9.4.1 Timers (*depends on equipment)

The DC/DS allows you to simultaneously use up to 10 different timers. This is useful to separately track motor run times, individual lap times, total flight time or just about anything else you could want. You can also name each of the timers. Once you create a timer, it is displayed in its own box on the desktop screen. The timer values are stored in each model's setup. The „Timers“ menu displays a list of all of the timers you have created.

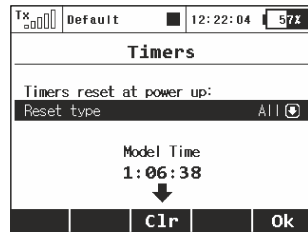
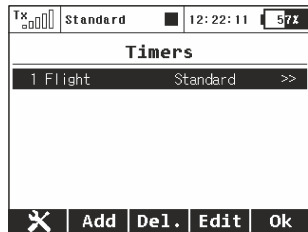

1. Model Time/Reset Timers at Power Up

By pressing **F1()** button you can choose which timers will be reset after turning on the TX or after selecting the model. By default, all timers with specified Short Reset option are cleared. In addition, it is possible to have all timers cleared or none. This option is model specific. The model time runs incrementally during flight (after pressing **F(4)** Start button on main screen or after starting any timer).

Button **F(3)** clears the model time.

It is possible to show the model time on the main screen „Timers/Sensors->Displayed Telemetry“.

2. Creating a new Timer

From the „Main Menu > Timers/Sensors > Timers“ menu, press the „**F2(Add)**“ button to create a new timer.

3. Deleting a Timer

Use the „**F3(Del.)**“ button to delete the selected timer.

4. Editing Timer Settings

Use either the „**F3(Edit)**“ button or the „**3D button**“ to enter the „Timer Detail“ menu. Then use the „3D button“ to select and edit the timer settings.

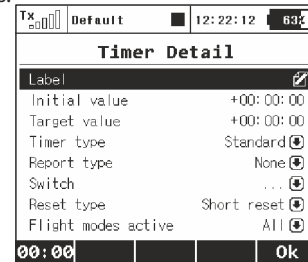

1. Editing a New Timer

a. Timer Name

When you add or change the timer name, the name is automatically displayed in that timer's box on the main desktop.

b. Initial Timer Value

This is where you can set the starting value for the timer. You can set a negative or positive value for this starting point.

c. Target Timer Value

Here is where you can set the target value for the timer. This can be set as a positive value or a negative value. The initial value and target value will determine the timer's direction. If the target value is smaller than the initial value, the timer will count down. If the target value is larger than the initial value, the timer will count up.

d. Timertype

There are three possible timer types:

- Standard – The timer starts or resumes when the chosen switch is triggered and the timer pauses when the switch is turned off. The timer's value is not reset when the timer is paused. Use the „F4(Stop)“ button to stop the timer.
- Laps – The timer starts when the chosen switch is triggered. Once the timer is started, each time the switch is triggered, the elapsed time is stored in memory and the timer resets to your chosen initial value. The lap number changes and the current lap time is displayed each time the switch is triggered. Use the „F4(Stop)“ button to stop the timer. Then, you can use the „3D button“ to scroll through the stored lap times.
- Free-Running – The timer starts counting when the chosen

switch is triggered. Once started, this type of timer can only be stopped using the „F4(Stop)“ button.

Use the „F5(Clr)“ button from the desktop to reset the timers.

e. Report type

You can use this item to select the type of audio alarm for the timer. Some of the choices will create an audible warning which sounds just before the target value is reached.

f. Switch

This item is used to assign the switch or button to start the timer.

See chapter 9.7: „Select input control“.

g. Reset type

The „F5(Clr)“ button is used to reset the timers.

If you select „Short reset“, the timer is reset by a short press of the „F5(Clr)“ button.

If you select „Long reset“, the timer is reset by a long press of the „F5(Clr)“ button.

h. Flight modes active

This item allows you to select which flight mode(s) for which the timer is active.

While you are in the „Timer Detail“ menu, the timer initial value is displayed in the first function key position (bottom, left).

9.4.2 Alarms

If you use the JETI telemetry system, in this menu you can set your alarm thresholds and choose which sound is played in the alarm condition. The transmitter supports both first generation Duplex and Duplex EX alarms.

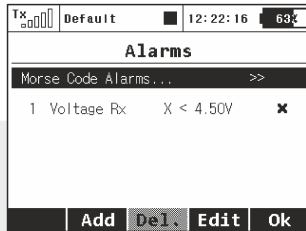

First Generation Alarms

First generation Duplex (non-EX) sensors generate their alarms as Morse Code. If you are using first generation Duplex sensors, then you must select **„Enable Morse Code Alarms“** using the **„3D button“**. When this option is selected, a table appears. In this table, the first column shows the Morse Code alphabet. The second column shows the **.wav** sound files associated with each letter. Use the **„3D Button“** to change the **.wav** file association as needed. The third column shows whether the selected **.wav** file for each letter is enabled. Use the **„3D button“** to enable or disable the alarm sound as needed. This configuration must be set for each model and is saved for each model independently.

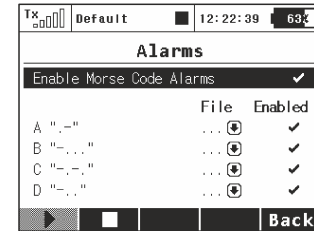

EX Alarms

Duplex EX sensors generate their alarms directly to the transmitter. The corresponding Duplex EX sensor must first be connected to a Duplex EX receiver and the receiver must be bound to the transmitter. It may take several minutes for the transmitter to initially communicate the sensors. The list of connected sensors is found in: **„Main Menu > Timers/Sensors > Sensors/Logging Setup“**.

For this operation, both the transmitter and all receivers and sensors must be connected and powered.

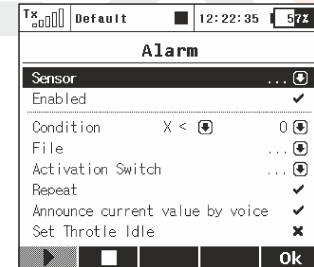

1. Creating an Alarm

Use the **„F2(Add)“** button to add an alarm. Then, in the **„Sensor“** item, select the sensor whose alarm limit you want to set.

2. Enable an Alarm

Using the „3D button“, select „Enabled“ and press to enable the alarm and display the alarm parameters.

3. Parameter Values

„Condition“ defines the condition which must be met in order to trigger the alarm. The value „X“ will vary with the sensor being used.

4. File

This item allows you to select the audio file that is played when the alarm occurs. Press „F1“ to play the selected audio file. Press „F2“ to stop playing the selected audio file.

5. Activation Switch

If the switch is assigned, the alarm is enabled or disabled according to the switch status.

6. Repeat

If the alarm condition occurrence is longer than the selected audio file, you can use this item to repeat the audio file. If a check mark is displayed then the audio file will repeat. If an „X“ is displayed then the audio file will play only once.

7. Announce current value by voice

EX Alarms provide the ability to tell you the actual value of a given sensor's variable. If you want the alarm value to be announced, then check this option.

8. Set Throttle Idle

With this item activated, you model's throttle will go to idle when the alarm condition occurs.

9.4.3 Vario (*depending on equipment)

Located in: „Menu->Timers/Sensors/Vario“. There are two types of acoustic signalling. The first one is controlled directly by the sensor's alarm. This is mainly useful if a non-EX MVARIO is installed inside the model. It is possible to assign a switch that enables or disables the sound. The slider at the bottom shows the actual value of climb/sink rate.

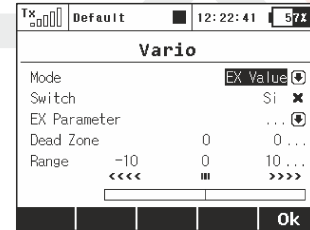
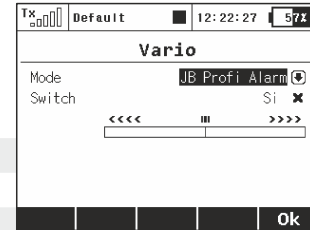

The second mode of the Vario is dedicated to EX sensors. The acoustic signalling varies directly depending on the actual numerical values sent by the sensor. It is also possible to assign a switch that enables the acoustic signal.

Other parameters displayed in this menu are:

- **EX Parameter.** Here you can select your sensor and its parameter which will act as a source for the Vario system. The Climb Rate is predefined by default (if the MVARIO EX is detected) but you are free to choose one of the other sensors and their parameters (for example: an RPM probe to indicate high revolutions).
- **Dead Zone** (negative and positive). This field sets an area around the centre of the range with no acoustic signal. Values are relative to the center.
- **Range** (minimum, center and maximum). Here you can define the full range of the sensor which will be indicated by the Vario system.

The actual value of the sensor and its appropriate Vario output are indicated at the bottom of the screen.

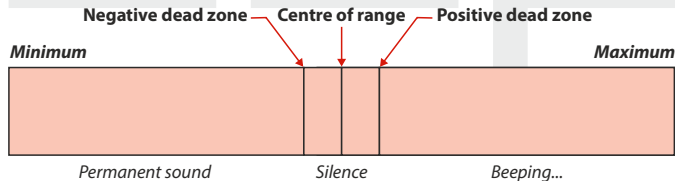

9.4.4 Voice Output (*depending on equipment)

This powerful function makes it easier for all modellers who need to know their actual telemetry values often but they don't want to (or cannot) look at the display because it may be inconvenient or dangerous.

Voice output for a timer

The first menu row represents settings for the voice output of a timer. The actual status of a single timer can be expressed by a synthesized voice. If you select the desired timer and a switch, every time the switch is activated the actual time is stated aloud.

If the timer type equals "Laps" type, another menu row equipped with checkbox appears below. In this row, "Report previous lap" allows you to determine whether you want to hear the time of a current lap which is already running or hear the time of the previous lap which has ended recently.

Voice output for telemetry

There are two independent queues dedicated to output telemetry values. The first queue repeats its message every x seconds (number of seconds elapsed is displayed over the F(1) button). You can also assign a switch to enable or disable the repeating of the countdown. Every time this switch is activated, the appropriate variables are reported by voice and then the countdown starts a new round until a timeout is reached.

The second voice queue specifies which variables are reported only once, after a single press of a switch. You can select a Trigger switch and a list of variables that are reported when the switch is activated.



By selecting the pushing the “Sensors & Variables” option using the 3D rotary button, you are able to choose which variables will be expressed by a synthesized voice. The first column represents the name of the sensor or variable. The Repeat option provides an easy way to add a variable to the Repeat queue or to remove a variable from the Repeat queue. By selecting the Trigger option, the specified variable is added into the Trigger queue, so that every time the Trigger switch is activated, the items in the Trigger queue are expressed by synthesized voice.

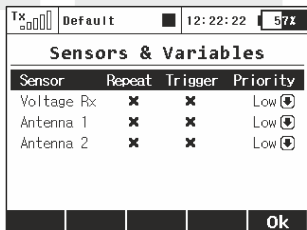

You may change the priority of any variable. This will also change the order of the reported items. Possible choices for priority are: Low, Medium and High. The order, top to bottom, is from High priority to Low priority.

9.4.5 Sensors/Logging Setup

This menu lists all of the Duplex EX sensors and their values which are operating in your model. When you connect a sensor to a Duplex EX receiver, it may take several minutes for the sensor to be recognized by the transmitter and added to the list.

In this menu you can edit the telemetry parameters of each sensor.

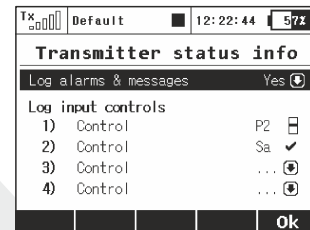
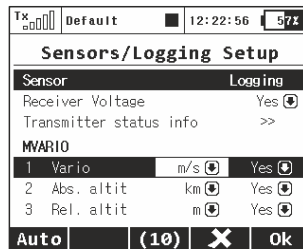

It is possible to store service information of the transmitter, alarms, and position of up to 4 controls (as markers) on your SD card. Then the data is a part of logged flight telemetry. In the menu „Timers/sensors -> Sensors/Logging” setup go to the item Transmitter status info and push the 3D button. In the menu it is possible to select whether the text information about the alarms and other general data about the transmitter state will be stored (by default it is disabled). Note that some PC programs for the evaluation of telemetry data can recognize the text information as an error in the data file. To view the information, you should use the built-in Data analysis application or update the PC program.

In this menu you can also select up to four controls whose position will be recorded in a file on the SD card. It is possible to select

between recording of proportional or two-state values (0% – 100%). The control positions are recorded with a fixed period of 0.2s. The data is a part of the standard telemetry record and can be displayed as the other parameters.

This application can easily be used as a marker to highlight interesting situations during the flight.

Conversion of Units

1. The voice synthesized telemetry units can be expressed in either metric or US units. It is also possible to display the telemetry units on the main screen in either format as well. The temperature is automatically converted according to the option selected in the Configuration menu. Conversion of the other units is accessible through the Sensors/Logging menu. You can choose from the following units:

Distance:

Metres (m), kilometres (km), feet (ft.), yards (yd.), miles (mi.).

Speed:

Metres per second (m/s), kilometres per hour (km/h), feet per second (ft/s), miles per hour (mph) and knots (kt.).

Deleting a sensor

Above the „F3” function button the transmitter shows the number of detected telemetry parameters from sensors and it is possible to reset any unnecessary entry using the „F4” button. However, if the button whose parameter has been deleted is still connected, the parameter will later be re-loaded. The transmitters can detect up to 32 telemetry items.

9.4.6 Displayed Telemetry

This menu lists all of the user information blocks which are displayed on the desktop. You can use this menu to manually add, delete, rename and resize the user information blocks displayed on the desktop.

User Block Overview:

„Flight mode” - Name of the current flight mode

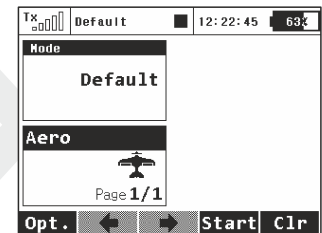
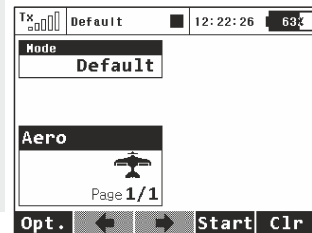

„Voltage Rx” - Receiver Voltage

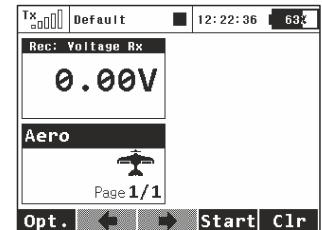
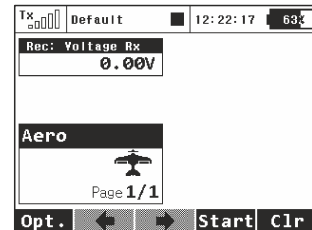

„Tx Battery“ - Transmitter Battery Status

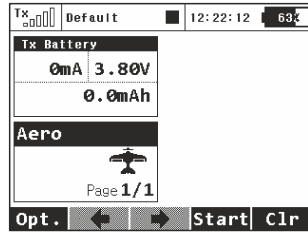
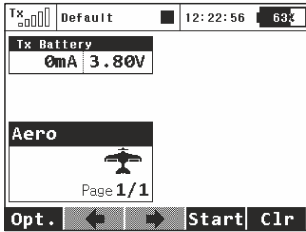

- Charge/Discharge current rate
- Actual Tx battery voltage
- Consumed capacity of Tx battery This value increases when the transmitter is in use and decreases when the battery is charging.

„Antenna“ - Information about the signal strength of each antenna. The percentage success of bidirectional communication, which is in the range of 0-100%, is shown in the box as well.

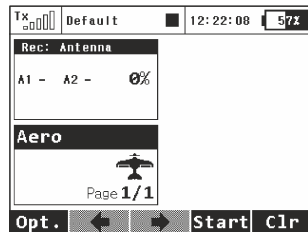
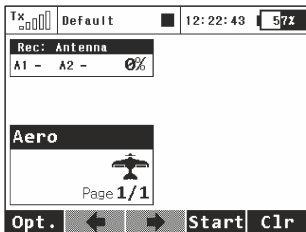

„User Name“ - User name.

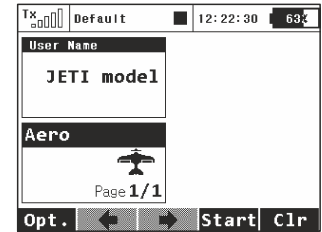
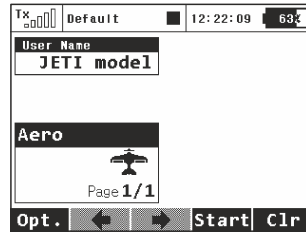

„JETibox“ - JETIBOX emulation screen

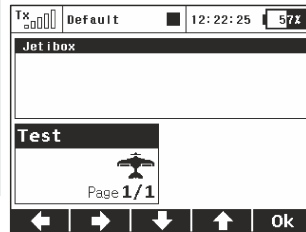

Press the ESC button to see and operate standard JETIbox controls.

The JETIbox emulator can also show data from both Tx modules and receivers. You can set a specific JETIbox window by selecting one of JB 1 or JB 2.

„Timer“ - Timer

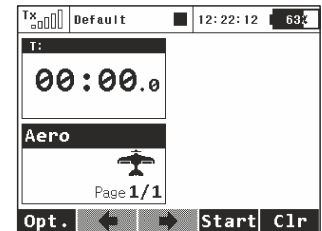
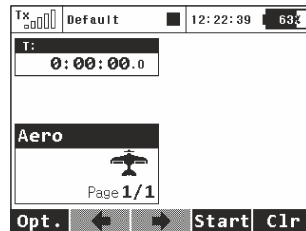

„Telemetry“ - Displays selected, connected telemetry sensor information.

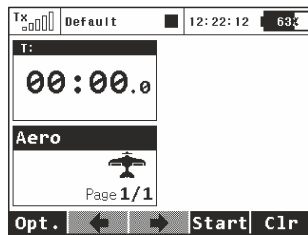
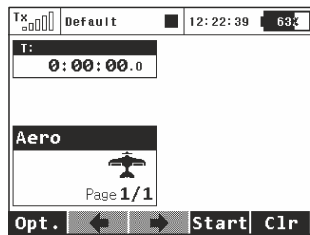

„Trim“ - Displays the position of the digital trims.

Note: When the trims are displayed on the main screen, the special Trim Screen no longer appears when any trim button is pressed.

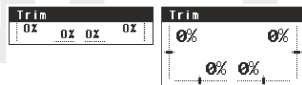

The user blocks can be either standard or double size. Double sized blocks obviously use up more of the desktop. In return, some of them display more data while others display the same data in a larger font.

Custom blocks can be linked to flight modes. This means that you can set up different groups of blocks for each flight mode creating a completely different desktop appearance from one flight mode to another.

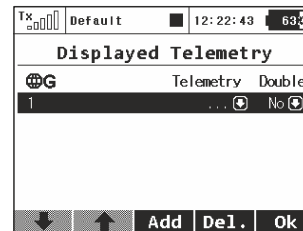

1. Creating a new user block

In the *“Displayed Telemetry”* menu, press the **“F3(Add)”** button to add a blank user block to the list. Using the **“3D button”** change the first item of the new block’s line to the type of block you want to create. Next, in the second line item, select whether you want the new block to be double size (yes) or not (no).

2. Change the User Block order

Using the **„3D button“** highlight your selected user block in the list. Use the **„F1“** and **„F2“** buttons to move your selected block up or down the list.

3. Deleting a User Block

Use the **„F4(Del)”** button to delete the selected user block from the list.

4. How the User Blocks are Displayed

The right end of the first line in the *„Displayed Telemetry”* menu displays a symbol to indicate if the list of user blocks is displayed for all flight modes or just the current flight mode. If the **„G (Global symbol)”** is displayed then the all of the listed user blocks are displayed in all of the flight modes. This means that when you change flight modes, your desktop display will not change. If the **„S**

(Separate symbol)“ symbol is displayed then the current list of user blocks are only displayed in the current flight mode. This means that when you change your flight modes, the desktop display will also change. When using separates you must create a user block list for each flight mode. You can change from Global to Separate by highlighting the first line and pressing the „**3D button**“.

9.4.7 Main Screen

This page displays additional desktop options.

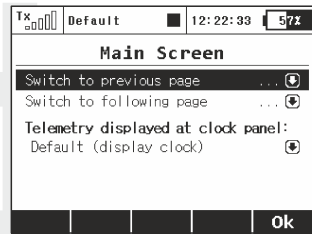

Switches can be used to flip pages on the main screen. You can assign two separate switches – the first one will always flip to previous page, the second switch will jump to the following page. You can also use any of the integrated accelerometer gestures (**DS-14/16 only**) to scroll through various telemetry screens.

Telemetry displayed at clock panel

Here is where you can select one telemetry parameter, which will appear at location of the digital clock on the top bar of the screen. This way you can select eg. displaying the instant current draw from the batteries, which is very helpful when balancing different servo travels.

Note: *Setting the display of the telemetry data on the top menu bar of the screen is saved as a part of the model configuration and it is displayed again when the transmitter is switched on. It is possible to select any simple numerical telemetry value, except GPS coordinates.*

9.5 Applications

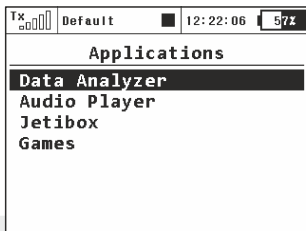

This menu displays some of the special applications within the DC/DS. (*depends on equipment)

9.5.1 Data Analyzer (*depending on equipment)

This function allows you to view telemetry log files after each flight. You don't have to take your PC to the airfield and download the data anymore. The analyzer is able to display up to three variables simultaneously in a graph with one variable displayed. The variables will alternate each time you press the F(5) 1/2/3 button while the graph is displayed.

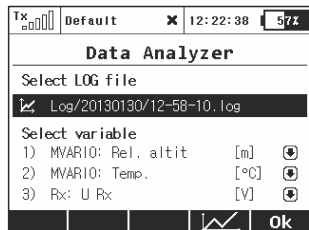

To view any logged telemetry data, open the Data Analyzer main window which is located under Applications menu item (see picture a)). Highlight a row beneath Select LOG file and press the rotary button. Browse through the contents of the SD

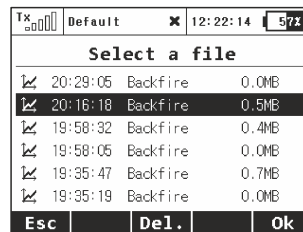
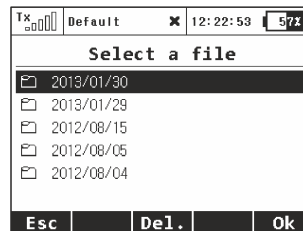

card and locate the desired file (pictures b) and c)). All files are in order by date and time, so it is easy to find the latest record. After the appropriate file has been selected, you will be redirected back to the screen a). There you can select up to three variables that will be alternately displayed in the graph.

By pressing the „F3 Del.“ button while browsing the log directory you are able to delete any log file and even directory.

After pressing the button „F4“, resulting graph is displayed. The X axis presents time domain, starting always at zero seconds.

The Y axis shows the values of the measured parameter from its calculated minimum to maximum. The Y axis has a dynamic range according to the actual values.

For convenience here is the list of available controls:

- You can scroll through the timespan of the log file quickly using the „F1“ and „F2“ buttons.
- You can also view the timeline at an increased speed on demand - just turn the rotary button to the left or to the right to move the timeline. After pressing the Menu button (or the rotary button itself), the timeline will begin moving with larger steps.

- „F3“Zoom In” and „F4“Zoom Out” decreases or increases the timespan of the whole graph.
- "F5" 1/2/3 button toggles between the variables that have been selected on the **screen a)**.

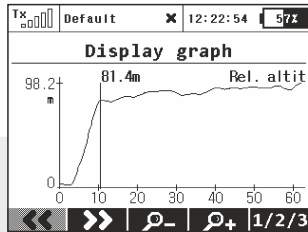

Note: You cannot display a log file which is currently being written to. To view the most recent file, you should stop logging and clear the flight using F(5) Clr button on the main screen. After that you can open the file in Data Analyzer.

9.5.2 Audio Player (*depending on equipment)

This menu lists all of the audio data stored on your transmitter’s internal memory.

The available audio files are stored in the Audio folder. Use the „3D control” to access and scroll through the Audio folder contents. The function keys provide playback control: „F1 (Esc)”, „F2 (Play)”, „F3 (Stop)”, „F4 (Vol-)” and „F5 (Vol+)”.



Audio files are supported in *.wav format.

9.5.3 JETIBOX

For maximum compatibility with 1st generation JETI DUPLEX, the DC/DS are equipped with a JETIBOX emulation function. This emulation shows its information in the legacy two-line display format. Use the function keys to navigate the JETIBOX menu in order to view or change the individual parameters. You can use also wirelessly access a bound receiver’s menu and/or any connected telemetry sensors connected to the receiver.

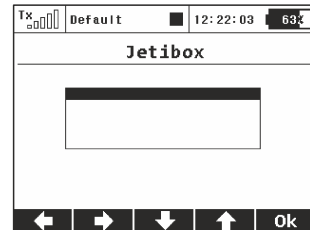

9.5.4 Games

Here you can find several simple games for fun and relaxation.

- Snake
- Tetris
- Gomoku
- Chess



9.6 System

- Use this menu to configure the system functions of your transmitter. All of the settings in this menu are global and do not change when you switch between models.

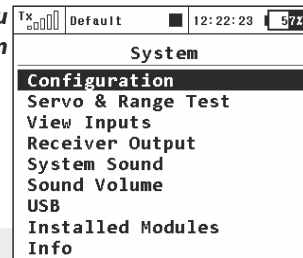

9.6.1 Configuration

Basic transmitter settings

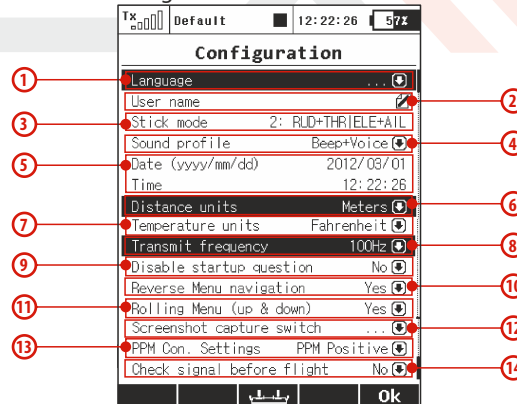

1. Language Setting

Use this menu to select the transmitter's language setting.

All of the transmitter's text and sounds will be changed based upon your selection.

Warning: After changing the transmitter's language you need to turn the transmitter off and back on for the change to take effect.

2. User Name

Enter the user name that you want to appear in the User block on the desktop.

3. Stick Mode

The transmitter supports Modes 1-4. To change the stick mode you can either use the „**3D button**“ to highlight and select the line item or simply press the „**F3**“ button. Either will take you into the Stick Mode menu. Use the „**F1-F4**“ buttons to make your selection and then press the „**F5(Ok)**“ button to confirm. The mode change will only be effective for new models. All of your stored models will retain their existing stick modes.

4. Sound Profile

This item allows you to select the sound profile for your transmitter. This determines how your transmitter will audibly communicate with you. You can select: quiet (mute), beep only, beep and voice (sound file) or voice (sound file) only.

5. Date and Time

Here is where you set the current date and time. The DC/DS will automatically observe the time change for Daylight Saving Time.

The time and date information is used when creating new models and for telemetry.

6. Distance units

This menu item allows you to select the distance units for your telemetry display. All telemetry data is automatically converted to your selected units for display.

7. Temperature units

This menu item allows you to select whether your temperature data is displayed in Fahrenheit or Celsius.

8. Transmit frequency

Says how often the stick positions will be refreshed. Please check the settings of your receivers prior setting this option to **100Hz**. The Output Period should be set to **"Auto"** and maximum of 3 servo groups (A, B, C) should be used. In other cases, the refresh rate will be applied according to receiver settings.

Warning: Use only digital servos that can handle 100Hz refresh rate.

9. Disable Startup Question

This menu item disables the question/confirmation during startup. (see Chapter 6)

10. Reverse Menu navigation

This menu item allows you to reverse the direction that the „**3D control**“ scrolls through the menus.

11. Rolling Menu (up&down)

If this option is set to No, the ability to scroll from the last item in the

menu directly to the first one will be disabled (and vice versa from the first row to the last).

12. Screenshot Capture Switch

This feature gives you the ability to create your own screenshots. After you activate the switch, a bitmap is created in the root folder of the SD card. You can create up to 1000 screenshots.

13. PPM connector settings

This option presents the possibility to configure the internal connector labeled as PPM Output (please refer to the chapter 3.7 PPM Output Connector):

- **Off** – the connector output (pin No. 4) will not generate any kind of signal.
- **PPM Positive** – the connector output (pin No. 4) will generate standard eight-channel PPM signal with positive pulses.
- **PPM Negative** – the connector output (pin No. 4) will generate inverted eight-channel PPM signal with negative pulses (0V level).
- **EX Data Stream** – the connector output (pin No. 4) will generate a digital data stream containing EX telemetry. The format of transmitted sensor/receiver data is described in the document JETI Telemetry Communication Protocol. The communication is unidirectional and cannot be used to configure the transmitter or any linked device. If you connect the RCDroidBox device to the transmitter, you will need to set this option.

14. Check signal before flight

It is possible to check the signal strength immediately after the model is turned on and connected to the transmitter. If you set Yes for this option, a warning message is generated for antenna signal levels less than 8. To make this function work correctly, you should be

located a distance of up to several meters from the model at the moment of switching it on. If the message is still present, please perform a range test and check the installation of the on-board electronic equipment.

9.6.2 Servo & Range Test

This menu allows you to perform a range test and servo tests.

During the servo test it is possible to send the test output to all of the channels which are active in the current model setup. The servo speed item allows you to adjust the travel time for the servos during the servo test. During the test, the servos will only be driven to their programmed maximum throws. You can select which servos will be included in the test.

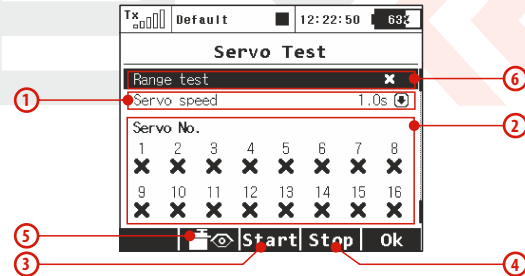

1. Servo speed

This menu item allows you to adjust the servo travel speed for the servo test.

The time shown is the time that it will take for the servo to move from one travel extreme to the other.

Note: A servo will only move to its programmed maximum throw.

2. Servo Number

Use the **“3D Control”** to select which servos will be included (check mark) or not included (X) in the servo test.

3. Starting the Servo Test

Press the **“F3 (Start)”** button to start the test for your selected servo outputs.

Once started, the servo test will continue to run even if you exit the menu.

You must stop the servo test before you can change any of the test settings (speed, output channel).

4. Stopping the Servo Test

Press the **„F4 (Stop)”** button to stop the servo test.

5. Display Receiver Outputs

Press the **„F2 (Servo Monitor)”** button to see the outputs being sent to your selected receiver channel.

6. Range Test

This menu line allows you to set the transmitter output to its range test mode.

See the receiver instructions for how to set the receiver to its range test mode.

9.6.3 View Inputs

This menu allows you to view input from the transmitter sticks, switches and knobs as detected by the transmitter software. This menu also contains a wizard to guide you through calibrating your transmitters proportional controls.

It is recommended to calibrate your proportional controls when:

- You change from modes 1-2 to modes 3-4
- The proportional controllers do not move to the extremes of the graphic display

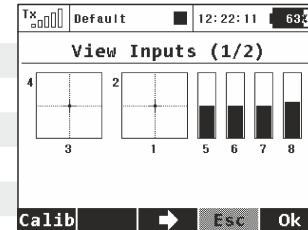

1. Calibration of Proportional Controls

Press the **„F1 (Calib)”** button. You will be asked if you really want to perform the calibration. Press the **„F5 (Yes)”** button to confirm. Follow the onscreen directions: Move all of the proportional controls slowly to their maximums a few times and return them to their centered positions. Press the **„F1 (Calib)”** button again to finish calibration. You will be taken back to the **„View Inputs (1/2)”** screen.

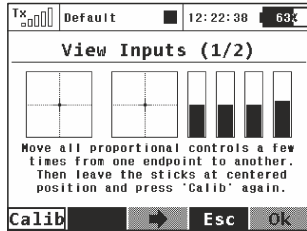

2. Proportional Input Display

The „*Display Inputs (1/2)*“ screen displays the currently detected position of each proportional control.

3. Switch Status Display

Press the „*F3*“ button to show the „*View Inputs (2/2)*“ screen.

This screen shows the type and currently detected position of the transmitter’s switches. Use the „*3D control*“ to select and edit any of the displayed switches. The „*Sk*“ and „*Sl*“ switch positions are reserved for the switches that can be mounted into the ends of your transmitter sticks.

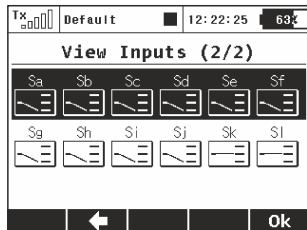

9.6.4 Receiver Output (Servo Monitor)

This menu displays the receiver output channels being generated by the transmitter. You can press the „*F3*“ button to see your programmed receiver output function names and their current output as a percentage. If you have modified the „*Channel Set*“ or „*Pin-Out Setting*“ of your Duplex receiver then the displayed receiver output channel numbers may not be accurate. If, however, your Duplex receiver still has its default channel settings then this list will be accurate.

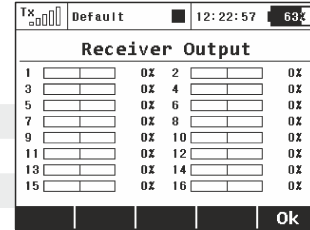

9.6.5 System Sound

This menu allows you to assign any available sound file to the system events.

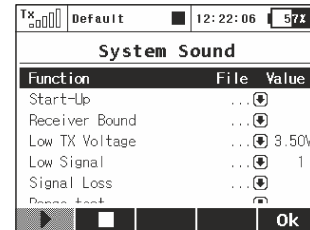

-*Start-Up* - associated file is played when the transmitter is turned on.

-Receiver Bound - Assigned file is played after the receiver is turned on and communication with the transmitter is established.

-Low TX Voltage - optional file with a warning at low transmitter voltage. You can also set an adjustable voltage level which says when the alarm will be activated.

-Low Signal - an optional file with a warning at low signal level. The file is played when the signal level of both antennas falls below a number specified in the parameter **"Value"**.

-Signal Loss - the associated file is played after signal from the receiver is lost.

-Range Test - the associated file is played repeatedly in the **"Range Test"** mode.

-Autotrim Active - the associated file is played repeatedly when the Autotrim function is active.

9.6.6 Sound Volume

Here you may select volumes for each part of the audio system individually. You are also free to assign any proportional control (stick or knob) for adjustment. The first row represents a master volume for the transmitter. Other volumes are then derived relative to this value.

- Beep Volume – controls volume of beeping and trimming.
- Vario Volume – intensity of vario tone signalling.
- Playback Volume – volume of played WAV files (Alarms, Audio Player and Sound on Event).

- Stop Playback Switch – after activating the assigned switch (in the picture Sj), all currently played WAV files are being stopped. This doesn't influence any further playback.

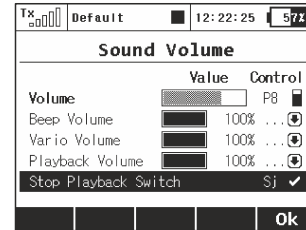

9.6.7 Installed Modules

This summary table is used to quickly view all the modules available in the transmitter. It is possible to determine whether the feature is enabled or disabled (indicated by tick, respectively crossing). You'll also find the number of elements useful for active modules and maximum values that are available for purchase as expansion packs.

The **DC-16** and **DS-16** transmitters in their basic version have all the modules activated on maximum possible values. With the **DS-14** transmitter it is possible to take advantage of the system that enables purchasing of the extended functions on swshop.jetimodel.com.

Installed Modules	
Registration code	
4444-4444-A402-17FA	
Accelerometer	✓
Double Path	✓
Data Analyzer	✓
Audio Player	✓
Voice Output	✓
Servo balancer	✓
Function Curves	✓
Throttle Limit	✓
Vario	✓
No. Channels	14 of 14
Fight Modes	6 of 6
Free Mixes	12 of 12
Logical Switches	10 of 10
Dev. Explorer: No. Commands	8 of 8
Sequencer	3 of 3
Timers	6 of 6
Displayed Telemetry	20 of 20
Sounds on Event	10 of 10
Alarms	20 of 20
Gyro settings	3 of 3
Function	14 of 14
Telemetry Controls	8 of 8

9.6.8 Limitations in copying models between transmitters

When copying models from one transmitter to another one, it is necessary to bear in mind that the transmitters may not have the same software equipment. Thus it is possible that the configuration of the activated modules may not correspond. In this case it is necessary to check individual features of the model. Loading the model memory to a different transmitter with different activated modules can be carried out, but according to the use of individual modules the transmitter can display warnings or does not allow loading the model. **The table (9.6.8)** shows the conditions under which a warning message will be displayed indicating that the model will be loaded in a limited form, or will not load at all.

9.6.9 USB

This menu allows you to establish communication between your DC/DS and a PC once you have connected the two with a USB cable.

How to connect your DC/DS to a PC:

1. Manually enter the menu: „Menu, >System, >USB“
2. When prompted, connect your transmitter and the PC with a USB cable.



Note: Leaving the menu disables the connection.

9.6.10 Info

This menu displays information about your DC/DS such as: product name, firmware version, available memory, etc. Press the „F5 (Ok)“ button to exit this menu.

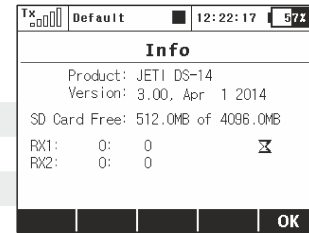

The table 9.6.8 - Limitations in copying models between transmitters

Module	Warning message	Possibility of loading with module not activated
Accelerometer	-	YES
Double Path	If the Double Path mode is activated (<i>menu Advanced Properties -> Wireless Modes/Trainer</i>)	NO
Data analysis	-	YES
Audio player	-	YES
Voice output	If any control starting the voice output is assigned (<i>Timers/Sensors -> Voice Output</i>)	YES
Servobalancer	If any check point of the servobalancer has a non-zero position on the Y axis (<i>menu Model->Servo setup</i>)	NO
Function curves	If a different curve type than „Standard“ is selected in the menu „Fine tuning ->Function Curves“	NO
Throttle limiter	If a control is assigned in the menu „Fine tuning ->Throttle Limiter“	NO
Vario	If the vario indication mode (<i>Timers/Sensors->Vario</i>) is not in the Off state.	YES
Number of channels	If an output of any function in the menu „Model->Servo Assignment“ is assigned to the transmitter channel that is not activated.	NO
Flight modes	If the number of flight modes of the model is higher than the number of flight modes in the transmitter.	NO
Free mixes	If the number of free mixes used in the model is higher than the number of free mixes available in the transmitter.	NO
Logic switches	If the logic switch is activated in the position that is not available in the transmitter.	NO
Device explorer: Number of remote commands	If the number of registered commands in the model is higher than the number of commands available in the transmitter.	YES
Sequencer	If the trigger switch is assigned to a sequencer that is unavailable in the transmitter.	NO
Timers	If the number of timers in the model is higher than the number of timers available in the transmitter.	YES
Values on display	If the number of values on display in the model configuration is higher than the number of values available in the transmitter.	YES
Event sounds	If the number of event sounds in the model is higher than the number of event sounds available in the transmitter.	YES
Alarms	If the number of active alarms in the model is higher than the number of alarms available in the transmitter.	YES
Gyro settings	If the number of active gyro functions in the model is higher than the number of functions available in the transmitter.	NO
Functions	If the number of model features in the model configuration is higher than the number of features available in the transmitter (<i>menu Model->Functions Assignment</i>)	NO
Telemetry controls	If the telemetry control is activated on the position that is not available in the transmitter (<i>menu Advanced Properties->Telemetry Controls</i>)	NO

9.7 Throttle Lock

Throttle lock is an important safety feature incorporated in your DC/DS transmitter. This feature effectively **"locks"** the throttle channel output leaving it at the last output value so that if your motor is stopped, it cannot start accidentally. To activate/deactivate the throttle lock go to the **„Main Menu“** and then press the **„F1 (lock/unlock)“** button. You will see the small padlock icon change to indicate the lock/unlocked condition. Additionally, when the throttle is locked, you will see a padlock icon appear in the center of the top bar of the desktop.

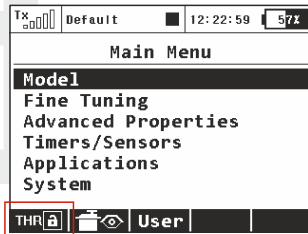

Hint: Use the throttle lock whenever you are handling a model whose power system is active to eliminate the chance of accidental activating the throttle and unexpected starting of the motor.

9.8 Select Input control

This menu allows you to select your desired input control device (switch, knob, stick or logical switch) for a given function. This menu will appear any time you edit an input control device selection. In this menu you can also assign/edit how a control device functions. You can set the control device to have two types of proportional output or just a simple ON/OFF function. From this menu you can also reverse the control device's functional direction.



1. Switch Assignment

When the menu appears, you can either press the „F1 (Log)“ button to select/edit a logical switch for your function or you can simply move the stick, switch or knob that you want to use to control the function. When you move the chosen control device it will be recognized and assigned to your function. The control device name and current status is displayed. Once the control is activated you can use the function buttons to configure the control device.

Hint: Think about what position/direction that you want the control to work and move the stick, switch or knob into position before you enter the assignment menu.

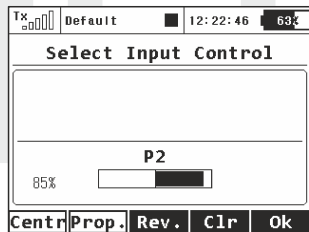

2. Proportional Settings

Press the „F2 (Prop)“ button to make the selected device control have either proportional or non-proportional control input. This setting will not be available for all control devices.

For example, you have selected a 3-position switch for your airbrakes. If you select:

- Non-proportional – The brake can have only two positions.
- Proportional – The brake can have up to three positions.

3. Reversing

Press the „F3 (Rev)“ button to change the control device activation direction.



This will not reverse the output direction of your function. It will simply reverse the direction of the control device (stick, switch, knob).

4. Removing the Switch Assignment

Press the „F4 (Clr)“ button to clear (remove) the selected control device from your function. You can then select another control device if you wish or press the „F5 (Ok)“ button to return to your function's menu without assigning any control device.

Once you are happy with your control device selection and configuration, press the „F5 (Ok)“ button or the „3D control“ to confirm.

5. Selecting other sources

You can take advantage of several control types that are available in the dialogue for selecting the control input (press F1 – F4 buttons to browse through different types of inputs):

- **P1 – P8** Physical proportional sticks and proportional controls.

- **Sa – SI** Physical configurable and replaceable switches.¹⁾
- **L1 – L16** Logical switches.²⁾
- **MAX** Logical maximum, can be configured as a switch that is always in an on-state.
- **GX, GY, GZ** Individual, independent axis of the built-in accelerometers (not available for DC-16).²⁾
- **G/L, G/R** Virtual controls switched on at the moment the transmitter is shifted to the left, or respectively to the right (not available for DC-16).²⁾
- **GXL, GXR** Virtual controls switched on at the transmitter tilt to the left, or resp. to the right (not available for DC-16).²⁾
- **Q1 – Q6** Individual sequencers.²⁾
- **Tr1 – Tr6** Digital trims as individual controls.
- **CH1 – CH8** Channel inputs of the PPM signal lead that is attached to the internal connector.
- **MX1 – MX8** Telemetry control inputs.²⁾

¹⁾ Configuration of the switches depends on the type of transmitter and also on which switches they are installed.

²⁾ Controls are available depending on the equipment of the transmitter.

Preview of the individual screens of the dialogue for selecting control input

a)

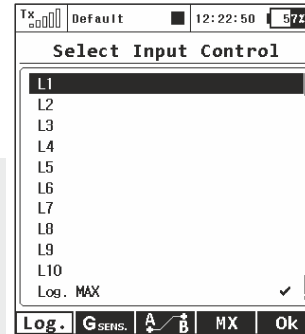

b)

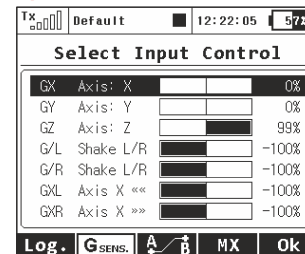

c)

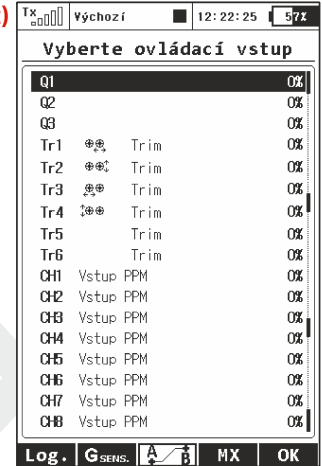

d)

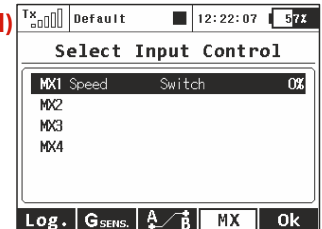

PPM input

The transmitter can handle up to 8 channels of the PPM input signal (please refer to the chapter 3.7 PPM Input/Output Connector). The signal should be present on the pin No. 1. To prevent any damage, you need to use the 3V logic level and protective elements on the

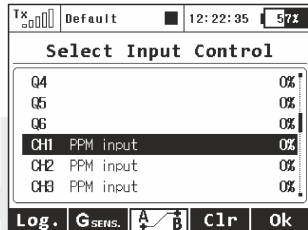

input. Throughout the model settings you can assign any of the PPM channels to any function of the transmitter. The PPM input is not linked with the trainer system in any way and works separately. It is possible to use the PPM input in cooperation with head-tracking systems etc.

9.9 Trim Menu

This menu displays the current trim settings. You can access this menu from the desktop by either pushing the „3D control“ or by simply pushing one of the trim buttons. In this menu, you can press the „F1 (Back)“ button to exit or push the „F5 (Auto)“ button to activate the Automatic Trim feature.

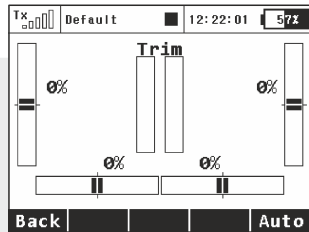

When the Automatic Trim is activated, the trim is automatically set based upon your flight stick positions. The farther the stick deflection, the faster the trim value is set in that direction. During the auto-trim process you still have normal control of your model.

9.10 How Transmitter Output Functions are Processed

This chart displays how the transmitter output functions are processed and at what point the various configuration choices affect the output function.

When you move a control device (top block), the output function will move according to its programmed function curve „Menu, >Fine Tuning, >Function Curves“. At the same time any programmed delay is also applied. Following this, any programmed exponential is applied and then any dual rate limits are also applied. The next step applies any mixes and/or programmed flight modes to the output function. Now, any servo setup configuration items (end point, subtrim, reversing, etc.) are implemented and then any trims or flight mode trims are applied to the channel's output function.

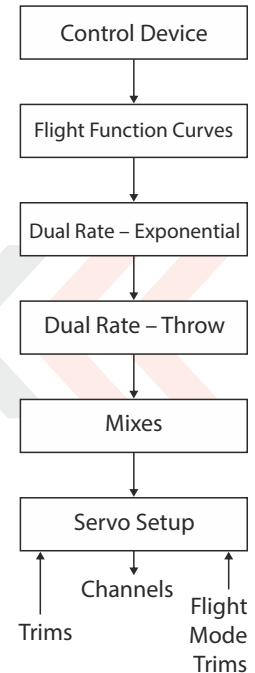

10 Transmitter to PC Connection

The JETI Duplex line of transmitters are equipped with a mini USB port. The Transmitters also come with a standard USB to mini USB cable which is used to connect your transmitter to a PC. The JETI Duplex system is fully compatible with Microsoft Windows XP and higher versions of Windows OS. After connection and confirmation your transmitter will be identified by the PC as another memory drive. While it is connected to a PC your transmitter's battery is also being charged via the USB port.

10.1 Memory & System Files

After your transmitter has been connected to a PC it will behave like standard external hard drive. Your transmitter's file directory is displayed on the PC screen. Pay close attention to moving, deleting or adding files to any open file directory, any changes performed here have a direct effect on your transmitter's internal data

File Directory

- Audio** – sounds, music, and acoustic warnings
- Config** – software configuration
- Lang** – language configuration
- Log** – telemetry data, all files use date stamp year/month/day
- Manual** – instruction manual
- Model** – programming files of individual models
- Update** – directory used for software updates
- Voice** – audio samples for speech synthesis
- Devices** – device definitions used for communication with intelligent devices based on **EX Bus** protocol

10.2 Update firmware

The JETI Duplex line of transmitters fully support future software updates. We recommend that you check the distributor's and/or manufacturer's web sites frequently for the most current update.

How to update your transmitter's firmware:

1. Connect your transmitter to a PC via USB port
2. Confirm the connection
3. On the PC screen, open the partition of the transmitter and extract the contents of the update file (*.Zip) to the root folder. Confirm "**overwrite existing files**" if prompted.
4. After the successful data transfer, disconnect your transmitter from the PC USB port and turn OFF the transmitter. The next time that you turn your transmitter ON, the software will be updated.

With any new firmware update no model setups or configuration settings will be lost. For safety, after performing a new update, we highly recommend that you check all functions, assignments, configurations, and model mixes. A list of new features is always released with the firmware update.

10.3 Sounds, Alarms & Acoustic Updates

At this time, the JETI firmware supports *.wav sound files. Any sound file can be assigned to any function, switch, flight mode, telemetry alarm, or music routine. Your applications are limited only by your imagination. All sounds must be copied to the "**Audio**" file.

10.4 System Backup

Data backup is as easy as the standard backup you can perform on your PC. You can save all your data onto a PC hard drive or CD. The saved data will, of course, reflect your last transmitter configuration and model settings. The data recovery is as easy as copying your backed up files back to the transmitter.

10.5 PC Joystick

DC/DS transmitters can be very simply used as a joystick interface for your PC. Connect your transmitter to a PC with the USB cable. Your operating system will identify the transmitter as an HID (Human Interface Device) gaming device.

10.6 Telemetry Data Logging

All telemetry data is stored on the internal SD card in the "Log" directory file. Telemetry data files are easily identifiable as .log files. The data files use date stamps with the "year/month/day" configuration. Flight logs can be viewed on the PC using the JETI "Flight Monitor" software.

10.7 Copying models between the transmitters

Configuration of all models in the transmitter are stored on the internal **SD card** in the directory **/Model/**. When you copy the selected model from one transmitter to another, simply copy the ***.jsn** file again to the **/Model/** directory of the second transmitter.

Note: *It is important to bear in mind that the two transmitters may not have the same software equipment, so it is possible that the configuration of the activated modules will not match each other. In this case it is necessary to check the individual functions of the model, since an attempt to load the model by another transmitter may end up with error message.*

11 Battery Safety Handling Rules

11.1 Transmitter Battery Pack

1. The Installed battery pack must be charged from an AC voltage source using only the included wall battery charger. The included adapters work with local utility services, each country might be supplied with a different type of charger.

EU: SYS1428-2412-W2E

UK: SYS1428-2412-W3U

US: SYS1428-2412-W2

Do not use any battery other than the manufacturer approved Power Ion 3200DC battery pack.

2. Always verify the correct polarity while connecting a transmitter battery pack. The red lead is positive "+" and the black lead is negative "-" polarity.

3. Never test a battery pack by shorting the wire leads. Do not allow the battery to overheat at any time.

4. Never leave your transmitter unattended at any time while it is being charged.

5. Never charge an overheated battery pack, or in an environment warmer than 158 F (70C).

6. During cold months always check the battery's capacity, do not rely on your radio's low battery warning system.

7. Always check your transmitter and receiver batteries prior each flight. Do not rely on your radio's low battery warning system.

8. Do not allow radio battery pack to come in contact with open flame, other heat source or moisture at any time.

11.2 General Safety Rules

1. Any repair, installation, or upgrade must be performed with caution and common sense. These will require some basic mechanical skills.



2. For any of the upgrades which require removing the radio back cover you MUST disconnect the transmitter battery pack before attempting any work.

3. It is imperative to store your radio in a controlled environment. Any extreme temperatures can cause damage to the sensitive electronics. A sudden change in temperature or humidity can create condensation which can permanently damage your radio.

4. Do not use radio during poor weather conditions. Any water or condensation can cause corrosion and could permanently disable your radio. If you suspect that moisture has entered your transmitter, turn it OFF, remove the back cover and let dry it out.

5. Avoid use in dusty environments.

6. The manufacturer is not responsible for any unauthorized modifications. Changes or modifications not expressly approved by the party responsible for compliance will void the user's authority to operate the equipment.

7. This is a sophisticated hobby product and not a toy. It must be operated with caution and common sense, always avoid any mechanical damage.

8. Always avoid operating close to devices that might cause harmful electromagnetic interferences.

9. Keep all moving parts clean and free of dust or fine debris that might damage the mechanical parts of the radio.

10. Do not point the transmitter antenna directly towards your model or a human body. The radiation pattern from the antenna will be shielded and provide poor connection to your model.
11. Never repair, re-install, or exchange the internal memory SD card for other type.
12. Avoid extreme temperatures as they can cause damage to the sensitive internal SD card.
13. Always perform a ground range check prior to your initial flight.

11.3 Flight Safety Check

1. Always verify the correct position of the switches, and the gimbals, prior turning ON your transmitter. Turn on the transmitter first, then receiver. JETI transmitters use **"Model Checking"**. This safety is designed so that the model memory stores the unique serial number of the receiver that has already been assigned to model. When the transmitter establishes communication with the receiver and the serial number does not match the number stored in the current model's setup, the transmitter displays a warning. You will then be able to accept the change or reject the change. If you accept the change, the transmitter stores the new receiver number into the model's setup and begins transmitting. If you reject the change, the transmitter will not communicate with the receiver and you will be allowed to select another model.
2. Perform a ground range check before each day's flying session.
3. Check the battery voltage on both the transmitter and the receiver battery packs.
4. Check all channel assignments, trim, mixes, and the correct

direction of movement for your flight surfaces.

5. Set motor/engine kill switch and test the power train.

11.4 Application

This product may be used for model airplane or surface (boat, car, robot) use only. It is not intended for use in any other application than control of the models for hobby, sport and recreational purposes.

11.5 FCC /IC information

This equipment has been tested and found to comply with the limits for a Class B digital device, pursuant to Part 15 of the FCC Rules. These limits are designed to provide reasonable protection against harmful interference in a residential installation. This equipment generates, uses, and can radiate radio frequency energy and, if not installed and used in accordance with the instructions, may cause harmful interference to radio communications. However, there is no guarantee that interference will not occur in a particular installation. If this equipment does cause harmful interference to radio or television reception, which can be determined by turning the equipment off and on, the user is encouraged to try to correct the interference by one or more of the following measures:

- Reorient or relocate the receiving antenna.
- Increase the separation between the equipment and receiver.
- Connect the equipment into an outlet on a circuit different from that to which the receiver is connected.
- Consult the dealer or an experienced radio/TV technician for help.

THIS DEVICE COMPLIES WITH PART 15 OF THE FCC RULES. OPERATION IS SUBJECT TO THE FOLLOWING TWO CONDITIONS (1) THIS DEVICE MAY NOT CAUSE HARMFUL INTERFERENCE, AND (2) THIS DEVICE MUST ACCEPT ANY INTERFERENCE RECEIVED, INCLUDING INTERFERENCE THAT MAY CAUSE UNDESIRE OPERATION.

Warning: Changes or modifications to this device not expressly approved by Esprit Model/JETI USA could void the user's authority to operate the equipment. "This equipment complies with FCC radiation exposure limits set forth for an uncontrolled environment. This equipment is in direct contact with the body of the user under normal operating conditions. This transmitter must not be co-located or operating in conjunction with any other antenna or transmitter."

Under Industry Canada regulations, this radio transmitter may only operate using an antenna of a type and maximum (or lesser) gain approved for the transmitter by Industry Canada. To reduce potential radio interference to other users, the antenna type and its gain should be so chosen that the equivalent isotropically radiated power (e.i.r.p.) is not more than that necessary for successful communication.

Conformément à la réglementation d'Industrie Canada, le présent émetteur radio peut fonctionner avec une antenne d'un type et d'un gain maximal (ou inférieur) approuvé pour l'émetteur par Industrie Canada. Dans le but de réduire les risques de brouillage

radioélectrique à l'intention des autres utilisateurs, il faut choisir le type d'antenne et son gain de sorte que la puissance isotrope rayonnée équivalente (p.i.r.e.) ne dépasse pas l'intensité nécessaire à l'établissement d'une communication satisfaisante.

This device complies with the Industry Canada license-exempt RSS standard(s). Operation is subject to the following two conditions: (1) this device may not cause interference, and (2) this device must accept any interference, including interference that may cause undesired operation of the device.

Le présent appareil est conforme aux CNR d'Industrie Canada applicables aux appareils radio exempts de licence. L'exploitation est autorisée aux deux conditions suivantes :

(1) l'appareil ne doit pas produire de brouillage, et (2) l'utilisateur de l'appareil doit accepter tout brouillage radioélectrique subi, même si le brouillage est susceptible d'en compromettre le fonctionnement.

12 Model Menu – Airplane/Sailplane

12.1 Butterfly Mix (Crow Mix)

Butterfly/Crow mixing is available with wing configurations of 2 aileron servos or more.

You can find the Butterfly menu in *“Fine Tuning, >Butterfly”*.

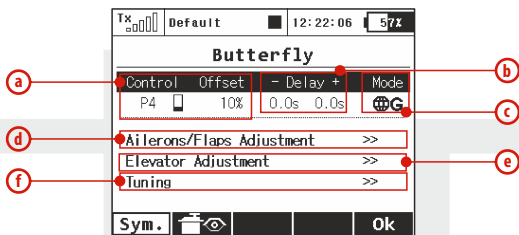

- a. Switch assignment for butterfly mix function
- b. Delay of deployment or retraction function
- c. Flight mode setting configuration
- d. Aileron/flap travel settings
- e. Elevator settings
- f. Butterfly tuning

Programming can be set according to specific wing and tail type configurations. For example if your model has **“Wing Type: 2 Ailerons”** and standard tail configuration, the Butterfly function can be setup to raise the ailerons (spoilers) and also to raise the elevator (compensation).

12.2 Aileron Differential

Aileron Differential is available with wing configurations of 2 ailerons servos or more.

You can find the Aileron Differential menu in *“Fine Tuning, >Aileron Differential”*.

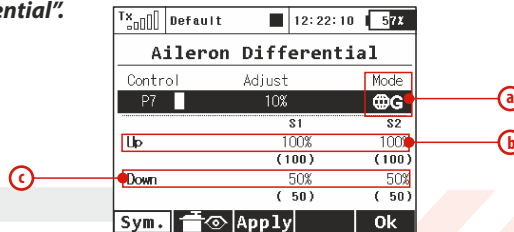

- a. Flight mode setting configuration
- b. Aileron „Up“ travel setting
- c. Aileron „Down“ travel setting

The aileron differential function reduces the downward travel of the aileron(s) to help eliminate any adverse yaw tendencies in rolling maneuvers. Semi-Symmetrical airfoils with an aileron in the down position induce higher drag than when the aileron is in the up position.

12.3 Ailevator

The ailevator function uses two servos for the elevator channel. Both sides can be programmed to be controlled independently.

If you have this selected as your model's tail type, you can find the Ailevator menu in **"Fine Tuning, >Ailevator"**.

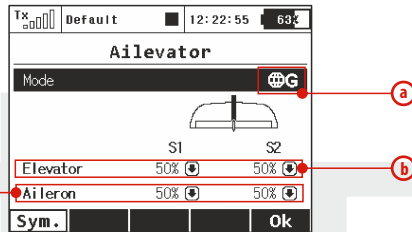

- a. Flight mode setting configuration
- b. Elevator travel setting
- c. Aileron travel setting

Your model's roll sensitivity is significantly greater with this mix.

To disable the mix, set your **"Aileron"** throw to zero. This will cause both elevator surfaces to move only when the elevator stick is moved.

12.4 V-Tail Mix

The V-Tail mix function uses two tail servos to control both the elevator function and the rudder function. See chapter 9.2.8

If you have this selected as your model's tail type, you can find the V-Tail menu in **"Fine Tuning" -> "V-Tail"**

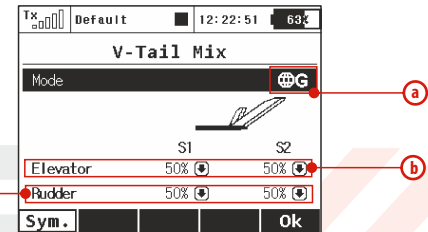

- a. Flight mode setting configuration
- b. Elevator travel setting
- c. Rudder travel setting

12.5 Delta/Elevon Mix

The Delta/Elevon Mix uses two servos for the control of both the elevator and aileron functions. This mix is most commonly used for Delta type aircraft.

If you have this selected as your model's tail type, you can find the Delta/Elevon menu in „*Fine Tuning*, >*Delta/Elevon*“.

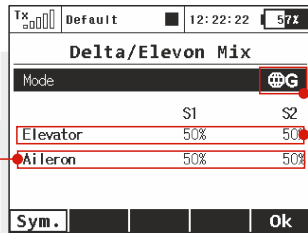

- a. Flight mode setting configuration
- b. Elevator travel setting
- c. Aileron travel setting

12.6 Spoilers to Elevator Mix

For models equipped with spoilers, the elevator is often used to compensate for any pitching tendencies generated when the spoilers are deployed. You can use one of the free mixers to set up this compensation.

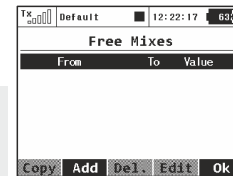

1. From inside the „*Fine Tuning*>*Free mixes*“ menu, press the „**F2 (Add)**“ button to create a new mix.



2. In the „*From*“ menu line, select the „**Spoiler**“ input function as the master function and in the „*To*“ line select the „**Elevator**“ for your slave function. The „**Master Value**“ represents the percentage of elevator travel as it relates to the spoiler travel. Press „**F5 (Next)**“ to save the mix.



3. To edit the mix simply highlight the mix and press the „**F4 (Edit)**“ button to go into the selected mix's advanced menu.

4. When you press the “F4 (Curve)” button you go directly to curve function menu screen.

5. From the curve type options select the “x>0” type. Adjust the curve, if necessary, so that the middle point is at the 50% output point (in the middle).

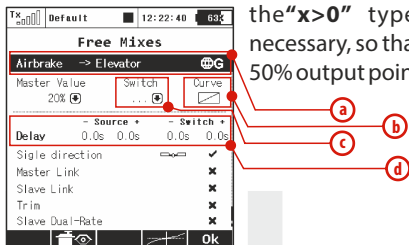

- a. Flight mode setting configuration
- b. Curve type icon
- c. Switch assignment for the spoiler mix function
- d. Delay for the mix function deployment or retraction

12.7 Ailerons to Rudder Mix

One of the most commonly used mixes for sailplanes, this mix function will allow you to mix rudder function with your ailerons to help your model have more coordinated turns. You can use one of the free mixers to set up this mixing function.

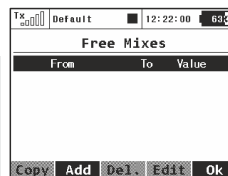

1. From inside the „Fine Tuning, >Free mixes” menu, press the „F2 (Add)” button to create a new mix.



2. In the „From” menu line, select the “Ailerons” input function as the master function and in the „To” line select the “Rudder” for your slave function. The “Master Value” represents the percentage of elevator travel as it relates to the spoiler travel. Press “F5 (Next)” to save the mix.



3. To edit the mix simply highlight the mix and press the “F4 (Edit)” button to go into the selected mix’s advanced menu.

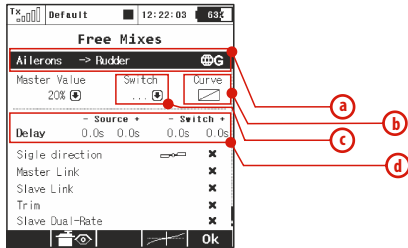

- a. Flight mode setting configuration
- b. Curve type icon
- c. Switch assignment for the spoiler mix function
- d. Delay for the mix function deployment or retraction

12.8 Rudder to Ailerons Mix

One of the most commonly used mixes for 3D planes, this mix helps to improve your control in knife-edge flight and while performing other 3D aerobatics. You can use one of the free mixers to set up this mixing function.

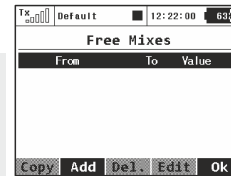

1. From inside the „*Fine Tuning*, >*Free mixes*“ menu, press the „**F2 (Add)**“ button to create a new mix.



2. In the „*From*“ menu line, select the „*Rudder*“ input function as the master function and in the „*To*“ line select the „*Ailerons*“ for your slave function. The „*Master Value*“ represents the percentage of elevator travel as it relates to the spoiler travel. Press „**F5 (Next)**“ to save the mix.

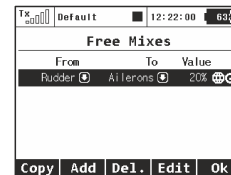

3. To edit the mix simply highlight the mix and press the "F4 (Edit)" button to go into the selected mix's advanced menu.

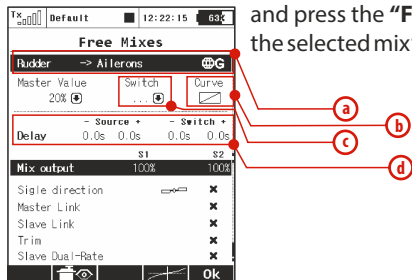

- a. Flight mode setting configuration
- b. Curve type icon
- c. Switch assignment for the spoiler mix function
- d. Delay for the mix function deployment or retraction

12.9 Butterfly (Crow) Mix

The basic configuration of the butterfly mix (also known as crow) is created by using ailerons, flaps, and elevator flying surfaces. The Butterfly/Crow mix is helpful for maintaining speed during fast descents and for creating controlled drag for spot landings. Typically, this mix is set up so that the ailerons travel up, the flaps travel down and the elevator is set to control any pitch changes.

You can find the Butterfly menu in „*Fine Tuning*, >*Butterfly*“.

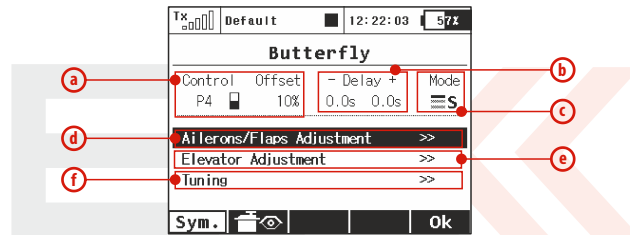

- a. Switch assignment for butterfly mix function
- b. Delay for the mix function deployment or retraction
- c. Flight mode setting configuration
- d. Aileron /flap travel settings
- e. Elevator servo travel setting
- f. Butterfly Tuning

12.10 Rudder to Elevator Mix

Another one of the most commonly used mixes for 3D planes, this mix helps to improve your control in knife-edge flight particularly to help with any coupling issues. You can use one of the free mixes to set up this mixing function.



1. From inside the „*Fine Tuning*, >*Free mixes*“ menu, press the „**F2 (Add)**“ button to create a new mix.

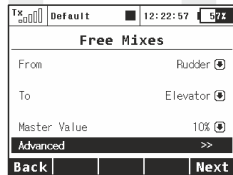

2. In the „*From*“ menu line, select the „*Rudder*“ input function as the master function and in the „*To*“ line select the „*Elevator*“ for your slave function. The „*Master Value*“ represents the percentage of elevator travel as it relates to the spoiler travel. Press „**F5 (Next)**“ to save the mix.



3. To edit the mix simply highlight the mix and press the „**F4 (Edit)**“ button to go into the selected mix's advanced menu.

- a. Flight mode setting configuration
- b. Curve type icon
- c. Switch assignment for the spoiler mix function
- d. Delay for the mix function deployment or retraction

12.11 Aileron to Flap Mix

This is also one of the more commonly used mixes for sailplanes. Mixing flaps with your ailerons will increase you model's aileron response. You can use one of the free mixes to set up this mixing function.



1. From inside the „*Fine Tuning*, >*Free mixes*“ menu, press the „**F2 (Add)**“ button to create a new mix.



2. In the „*From*“ menu line, select the „*Flaps*“ input function as the master function and in the „*To*“ line select the „*Ailerons*“ for your slave function. The „*Master Value*“ represents the percentage of elevator travel as it relates to the spoiler travel. Press „**F5 (Next)**“ to save the mix.

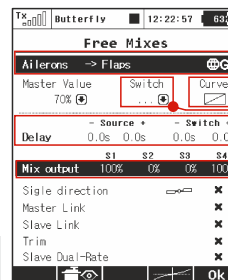

3. To edit the mix simply highlight the mix and press the „**F4 (Edit)**“ button to go into the selected mix's advanced menu.

- a. Flight mode setting configuration
- b. Curve type icon
- c. Switch assignment for the spoiler mix function
- d. Delay for the mix function deployment or retraction
- e. Output travel settings for the individual servos

12.12 Aileron to Flap Mix (Brake Variation)

This mix variation is used if your model is equipped with 4 flaps and you want only the inner flaps (the set closest to the fuselage) to move with the ailerons while leaving the outer flaps to be used only for braking.

Except for the last step below, you will create this mix exactly as described above. (See 12.11)

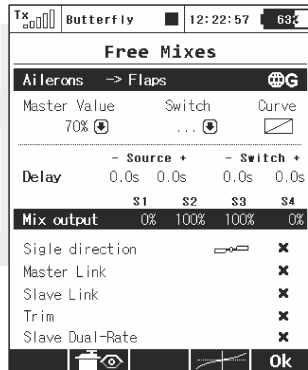

Set the „Mix Output“ for columns „S1“ and „S4“ to 0%. This setting will not allow the „S1“ or „S4“ flaps to move with the aileron mix function.

12.13 Elevator to Flap Mix

If your model is equipped with flaps you might want consider mixing the flaps to the elevator. In some model designs this mix can improve the elevator response. You can use one of the free mixers to set up this mixing function.



1. From inside the „*Fine Tuning*, >*Free mixes*“ menu, press the „F2 (Add)“ button to create a new mix.

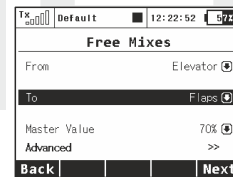

2. In the „From“ menu line, select the „Elevator“ input function as the master function and in the „To“ line select the „Flaps“ for your slave function. The „Master Value“ represents the percentage of elevator travel as it relates to the spoiler travel. Press „F5 (Next)“ to save the mix.

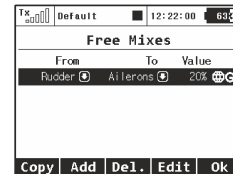

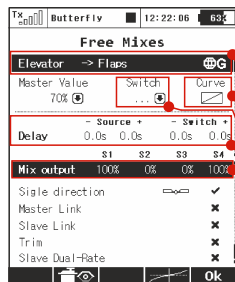

3. To edit the mix simply highlight the mix and press the "F4 (Edit)" button to go into the selected mix's advanced menu.

- a. Flight mode setting configuration
- b. Curve type icon
- c. Switch assignment for the spoiler mix function
- d. Delay for the mix function deployment or retraction
- e. Output travel settings for the individual servos

If your wing configuration has 4 flap surfaces and you only want the outer flaps (the set furthest from the fuselage) to move with the elevator with this mix then set the „Mix Output“ for columns „S2“ and „S3“ to 0%. This setting will not allow the „S2“ or „S3“ flaps to move with the elevator mix function.

12.14 Flaps Mix – Camber Control

This is another popular sailplane mix. This mix allows you to effectively change the airfoil of your model's wing by combining the flaps and ailerons to lower the trailing edge (under camber) of the wing. This helps to lower your flight speeds during landings or while soaring. „Under camber“ is added to the wings when the flaps and ailerons are deflected a little bit downward. Adding under-camber means that the bottom surface of the wing becomes more concave. To use this mix your wing configuration must be „2Ail“ or higher.

You can either use free mixer to set up this mix or you can use the Butterfly mix. You can find the Butterfly menu in „Fine Tuning, >Butterfly“.

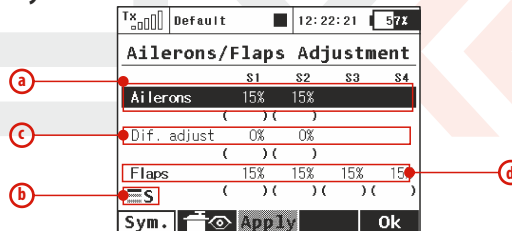

- a. Aileron servo travel settings
- b. Flight mode setting indicator
- c. Aileron differential adjustment
- d. Flap servo travel settings

12.15 Throttle Cut (Kill Switch)

This safety feature is mainly for models using glow or gasoline engines as their main source of power. Electric models can also highly benefit from this safety feature. The Throttle Cut function can be activated using any assigned switch, knob or stick. By editing the **“Output Value”** item, the throttle output will move to the user defined (completely off) throttle position once the assigned switch is activated. When the Throttle Cut is active, your throttle stick has no effect on the throttle output.

You can find the Throttle Cut menu in: **„Advanced Properties, >Other Model Options, >Throttle Cut“**.

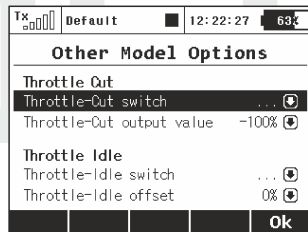

12.16 Throttle Idle

This feature is used to set the idle position for your throttle and will prevent your engine from shutting-off when you move throttle stick to its low position. The minimum throttle setting is defined by editing the **“Throttle-Idle Offset”** value. When this function has been activated, the minimum throttle setting (idle point) is defined by the offset value as a percentage. Standard throttle function is not affected by the idle offset setting. You can find the Throttle Cut menu in: **„Advanced Properties, >Other Model Options, >Throttle Idle“**.

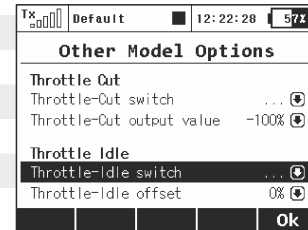

13 Accessories for Transmitters

13.1 Tray for DC/DS

DC-Blue

DC-Black

Bracket
Holder for transmitter
DC/DS

DC-Carbon Design
(PCD-3)

DS-Blue

DS-Black

Hand Pads
for Pult PCD-2, PCD-3

13.2 Stick Ends for DC/DS



3 position switch



2 position switch



Button switch



Potentiometer



Spare stick ends

13.3 Replacement switches

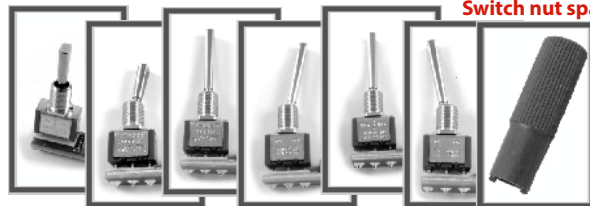

Switch nut spanner

13.4 Straps for DC/DS



Cross strap for DC-16



Strap for DC-16



Strap for DS

13.5 Charging

**Car Charger
DC/DS**



**Charger
DC/DS**



UK

EU

13.6 Other



Aluminum Case



**Spare Battery
for DC/DS**



Blind Plug DC-16



USB-miniUSB cable



**USB adapter
to update receivers
and other products**

13.7 Overview of the DS-14 expansion modules (transmitter equipment comparison)

	DS-14	DS-16	DC-16
New possibilities	charged	free of charge	free of charge
Channels	8 (up to 14)	16	16
Accelerometer	○	●	●
Secondary RF module in function: teacher, double p.	○	●	●
Flight modes	3 (up to 6)	10	10
Free mixes	5 (up to 12)	20	20
Graphs	○	●	●
Audio player	○	●	●
Logic switches	0 (up to 10)	16	16
Number of remote commands	0 (up to 8)	16	16
Sequencer	0 (up to 3)	6	6
Timer	3 (up to 6)	10	10
Values on display	10 (up to 20)	40	40
Event sounds	5 (up to 10)	20	20
Alarms	10 (up to 20)	40	40
Voice output	○	●	●
Gyro settings	1 (up to 3)	3	3
Servo balancer	○	●	●
Function curves	○	●	●
Throttle limiter	○	●	●
Vario	○	●	●
Telemetry Controls	0	5	●
Number of control inputs	14 (up to 18)	16 (up to 18)	16 (up to 20)
Material of sticks	Polyamid	Aluminium	Aluminium
Resolution of sticks	4096	4096	4096
Hall sensors	●	●	●
Internal memory, SD card	4 GB	4 GB	4 GB
RF modules	2	2	2
Number of antennas	4	4	2
LCD backlight	3,8" 320x240 pixels	3,8" 320x240 pixels	3,8" 320x240 pixels
Weight [kg]	1,2	1,25	1,5
Dimensions [mm]	194x233x40	194x233x40	230x270x40
Transmitter Battery Pack [mAh]	Power Ion 152P 3200	Power Ion 152P 3200	Power Ion 152P 3200
Battery Charger	●	●	●
Receiver included	-	R9 EX 80US	-
Straps	-	●	-

- - The module is not included in the basic version
- - This function is available after purchasing the module



Declaration of Conformity

Declaration of conformity in accordance with the Statutory rules n. 426/2000 Sb. and Directive 1999/5/EC (R&TTE)

Producer: JETI model s.r.o.
Lomná 1530, 742 58 Příbor, Česká republika
IČ: 26825147

declares, that the product

Type designation: transmitter DUPLEX EX
Specification: DC-16
Frequency band: 2400,0 – 2483,5 MHz
Channel range: 5 MHz
Max power: 100 mW e.i.r.p.
Type of modulation: FHSS
Transmission speed: max. 2 Mbps
Equipment class: 2

Complies with essential requirements and other relevant provisions of the Statutory rules n. 426/2000 Sb. (and the R&TTE Directive)

Harmonised standards applies:

Measures for the efficient use of the radio frequency spectrum

EN 300 328 V 1.7.1:2007-06

Protection requirements concerning electromagnetic compatibility

EN 301 489-1 V 1.8.1:2008-10
EN 301 489-17 V 1.3.2:2008-12
EN 301 489-1 V 1.8.1:2008
EN 301 489-3 V 1.4.1:2003

Příbor, 1.6.2012

Ing. Stanislav Jelen,
Managing Director



Declaration of Conformity

Declaration of conformity in accordance with the Statutory rules n. 426/2000 Sb. and Directive 1999/5/EC (R&TTE)

Producer: JETI model s.r.o.
Lomná 1530, 742 58 Příbor, Česká republika
IČ 26825147

declares, that the product

Type designation: transmitter DUPLEX EX
Specification: DS-16
Frequency band: 2400,0 – 2483,5 MHz
Channel range: 5 MHz
Max power: 100 mW e.i.r.p.
Type of modulation: FHSS
Transmission speed: max. 2 Mbps
Equipment class: 2

Complies with essential requirements and other relevant provisions of the Statutory rules n. 426/2000 Sb. (and the R&TTE Directive)

Harmonised standards applies:

Measures for the efficient use of the radio frequency spectrum

EN 300 328 V 1.7.1:2007-06

Protection requirements concerning electromagnetic compatibility

EN 301 489-1 V 1.8.1:2008-10
EN 301 489-17 V 1.3.2:2008-12
EN 301 489-1 V 1.8.1:2008
EN 301 489-3 V 1.4.1:2003

Příbor, 19.4.2013

Ing. Stanislav Jelen,
Managing Director

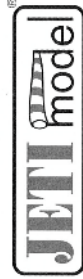

Declaration of Conformity

Declaration of conformity in accordance with the Statutory rules n. 426/2000 Sb. and Directive 1999/5/EC (R&TTE)

Producer: JETI model s.r.o.
Loměná 1530, 742 58 Příbor, Česká republika
IC 26825147

declares, that the product

Type designation: transmitter DUPLEX EX
Specification: DS-14
Frequency band: 2400,0 – 2483,5 MHz
Channel range: 5 MHz
Max. power: 100 mW e.i.r.p.
Type of modulation: FHSS
Transmission speed: max. 2 Mbps
Equipment class: 2

Complies with essential requirements and other relevant provisions of the Statutory rules n. 426/2000 Sb. (and the R&TTE Directive)

Harmonised standards applies:

Measures for the efficient use of the radio frequency spectrum

EN 300 328 V 1.7.1:2007-06

Protection requirements concerning electromagnetic compatibility

EN 301 489-1 V 1.8.1:2008-10
EN 301 489-17 V 1.3.2:2008-12
EN 301 489-1 V 1.8.1:2008
EN 301 489-3 V 1.4.1:2003

Příbor, 7.4.2014

Ing. Stanislav Jelen,
CEO

ENGLISH**Information on Disposal for Users of Waste Electrical & Electronic Equipment (private households)**

This symbol on the products and/or accompanying documents means that used electrical and electronic products should not be mixed with general household waste.

For proper treatment, recovery and recycling, please take these products to designated collection points, where they will be accepted on a free of charge basis. Alternatively, in some countries you may be able to return your products to your local retailer upon the purchase of an equivalent new product.

Disposing of this product correctly will help to save valuable resources and prevent any potential negative effects on human health and the environment which could otherwise arise from inappropriate waste handling. Please contact your local authority for further details of your nearest designated collection point.

Penalties may be applicable for incorrect disposal of this waste, in accordance with national legislation.

For business users in the European Union

If you wish to discard electrical and electronic equipment, please contact your dealer or supplier for further information.

Information on Disposal in other Countries outside the European Union

This symbol is only valid in the European Union.

If you wish to discard this product, please contact your local authorities or dealer and ask for the correct method of disposal.





JETI model s.r.o.

Lomená 1530, 742 58 Příbor

www.jetimodel.com

