



MANUAL

SPEED SENSOR

MSPEED, MSPEED 450

INTRODUCTION	1
DESCRIPTION	2
CONNECTING MSPEED	2
MSPEED MENU	3
INSTALLATION	7
TECHNICAL DATA FOR MSPEED	8
WARRANTY	8

Publisher JETI model s.r.o

20.5.2014

Introduction

MSPEED is a sensor which measures the speed of a flying model through the air, to provide the indicated airspeed (IAS). The reporting of airspeed can be very instructive with regard to the control of a flying model, for example allowing the pilot to determine the models stall speed and set an alarm to indicate when the model falls below this speed. Another function of the sensor is to allow the pilot

to set a desired speed and a step above or below this speed at which an acoustic signal should be sounded by the transmitter module. To facilitate easier reading of the indicated airspeed, a bar graph is displayed marking the appropriate configured steps. The measurement of airspeed is based on the principle of change in dynamic pressure, measured by a pitot tube, which is connected by silicon tubing. With the help of the wireless Duplex system, this sensor information can be reported to the pilot in realtime, allowing immediate feedback in airspeed changes and a deviations from the configured steps.

Description

MSPEED consists of a base unit and a pitot tube with static pressure measurement, connected by silicone hoses. The base unit includes the sensor for measuring the relative pressure with two entrances. One entrance is marked red and other is clear. The pitot tube has two corresponding exists, one marked red, the other not. To ensure correct operation, the red tube should be connected between the base unit and the pitot using the marked input/output. The clear tube should be connected between the unmarked input/outputs.

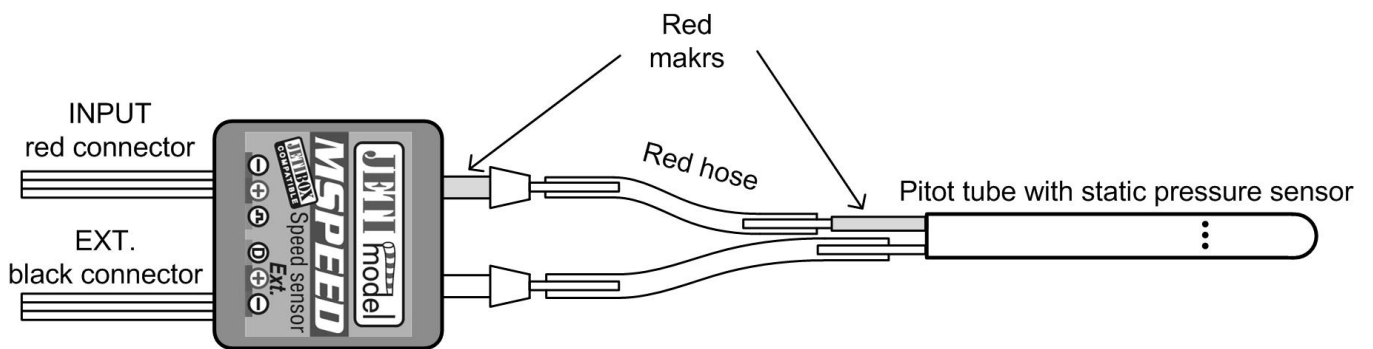

Connecting MSPEED

The base unit features two three-wire cables. The cable with the red JR plug, marked INPUT provides control signals to the unit. The other cable marked EXT (black plug) allows data transfer between the sensor and the Duplex system or the Jeti Box.

1.1 Connecting MSPEED to the Jeti Box

In this case, the Jeti Box requires a power-supply of between 5-8.4V, such as a receiver battery, which should be connected to the socket marked +, - of the Jeti Box. The three-wire cable from the MSPEED, with the black plug, should be connected to the appropriate socket of the Jeti Box (The socket marked *pulse*, +, -). The red plug of the MSPEED base unit, is not required. Please note in this configuration, alarms cannot be generated, but will be displayed on the Jeti Box screen.



1.1 Connecting MSPEED to the Duplex Receiver

In this case, MSPEED is connected directly to the Duplex receiver, using the socket marked EXT. The sensor takes its power from the receiver. The black plug from MSPEED should be inserted into the EXT. Socket of the receiver (Observe correct orientation) and the red plug from MSPEED can optionally be connected to a spare channel, in order to control the alarm signals.

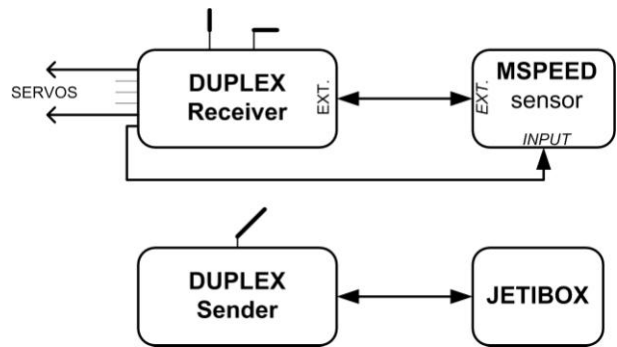

1.2 Connecting MSPEED to the Duplex Receiver via the Expander

In this case, additional sensors can be connected to the receiver, if required, via the Expander. The three-cable wire from the MSPEED with the black plug, should be connected to the Expander, observing the correct orientation. The Expander should be connected to the Receiver via the Expander's black JR plug, into the socket marked EXT. on the Receiver. The optional red plug of the MSPEED can be connected to a spare receiver channel, if desired.

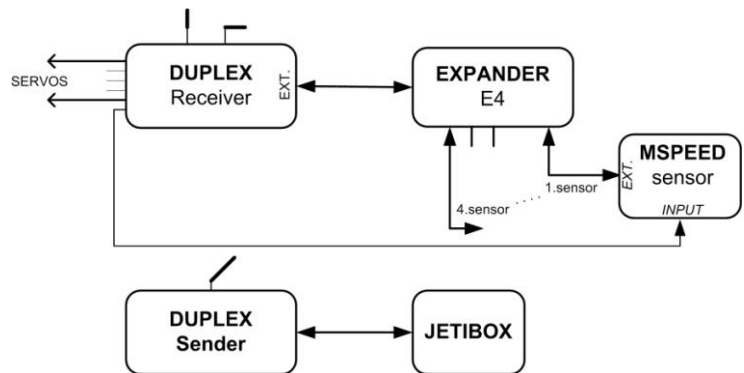

MSPEED Menu

For parameter setting and data read-outs, the Jeti Box terminal is used. After connecting MSPEED as per section 3 and assuming that if required, the Jeti Box is connected to your Duplex transmitter module; then the MSPEED sensor can be chosen on the Jeti Box. The initial screen shows the sensor identification and the actual measured speed. The second line shows the bar chart and the current

speed. The bar chart has eight positions and the ‘>’ character indicates a speed step, which is equal to the ‘Step of graph’ value within the BAR GRAPH settings.

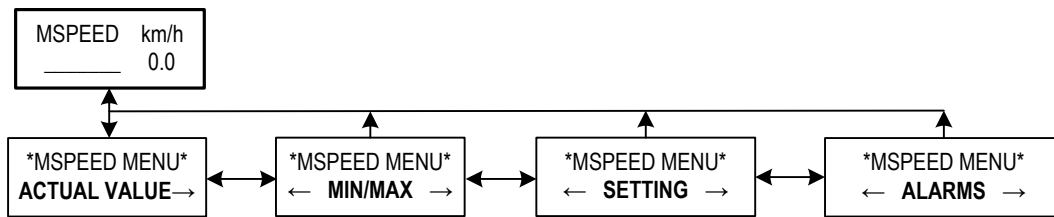

1.3 ACTUAL VALUE

MSPEED MENU: Actual Value – By pressing the D (Down) key of the Jeti Box, we can see the actual measured values.

Actual speed – Shows the actual measured speed. Can be reset by simultaneously holding L and R keys (Left and Right), which should be performed if the model is at rest.

Temperature – Shows the current temperature measured by MSPEED.

1.4 MIN / MAX

MSPEED MENU: MIN / MAX - By pressing the D (Down) key of the Jeti Box again, we can see the recorded extremes of speed and temperature, which have occurred. Recorded extremes are automatically deleted after power-up only when the current actual speed exceeds that specified by the “*Setting → Bar Graph → Minimal Value*” setting. If this value is not exceeded, then the recorded extremes from the previous use of the sensor are shown.

MIN/MAX Speed – Shows the minimum and maximum speed recorded during the last operation.

MIN/MAX Temp. – Shows the minimum and maximum temperature recorded during the last operation.

1.5 SETTING

MSPEED MENU: SETTING – By pressing the D (Down) key of the Jeti Box again, we access the settings menu of the sensor.

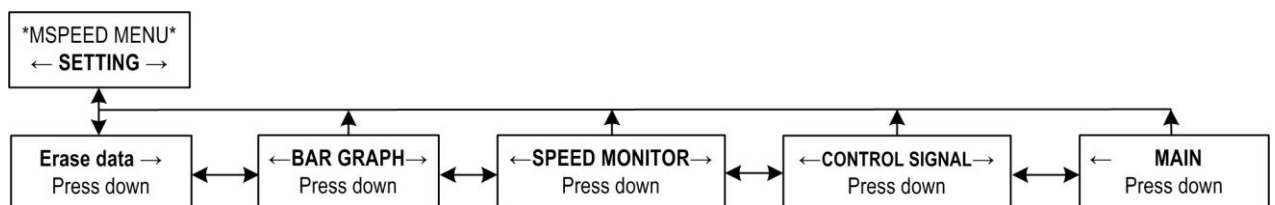

Erase Data – By pressing the Down key, the minimum and maximum values are erased.

BAR GRAPH - by pressing the Down key, the options for the bar graph are displayed

←BAR GRAPH→
Press down

Minimal value – The minimum value of the graph. When this value is exceeded, the first portion of the graph is filled and any minimum and maximum values are erased.

Minimal value
< 30.0 km/h >

Step of graph – Step of the bar graph.

Step of graph
< 10.0 km/h >

For example: If the *Minimal value* is 20 km/h and *Step of graph* is 10 km/h and the current speed is 51 km/h, then the bar graph will appear as follows:

Actual speed [km/h]							
20	30	40	50	60	70	80	90
>	>	>	>	__	__	__	__

SPEED MONITOR By pressing the down key, we access the settings menu for the speed indicator, which serves to aid in keeping your model at an optimum speed and aid awareness of changes in that speed.

←SPEED MONITOR→
Press down

Beep of speed – Set the independent audible speed indicator. This does not affect the alarm.

Beep of speed
OFF >

- *ON* – Sound is switched on permanently.
- *ON OVER* – Sound is only given when speed is above “Setpoint speed”.
- *ON BELLOW* - Sound is only given when speed is above “Setpoint speed”.
- *OFF* – - Sound is off (Does not affect the alarm).

Setpoint speed
< 100.0 km/h >

Setpoint speed – Expected average speed.

Speed level
< 5.0 km/h >

Level of speed – The step in speed with which the sound changes

Beep Period
< 1.00s >

Period of beep – The length of the sound

The graphic below shows the speed curve in relation to time. Setting the desired speed value (“Setpoint speed”) and speed levels (“Level of speed“) determines how the acoustic signal will change. If the current speed is higher than the desired speed, this is signalled by beeps and the appropriate number of tones proportional to the difference in speed. Speed below the desired level is indicated with long notes and the number of tones in this case determines the shortfall of speed. These sounds can be disabled in the *Settings* → *Control signal* option menu.

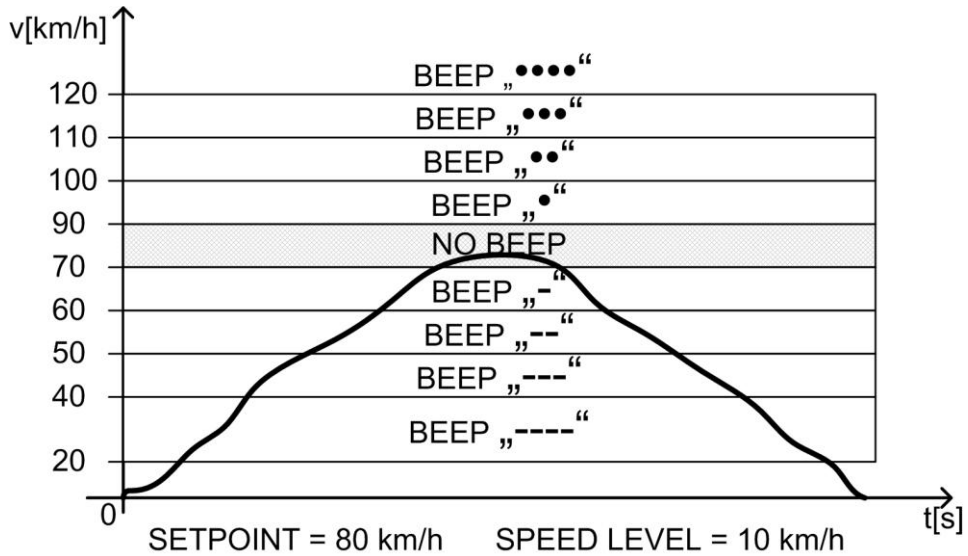

CONTROL SIGNAL – By pressing the Down key, we can modify options relating to the input control signal. This allows simple switching on/off of the audible alarms generated by MSPEED.

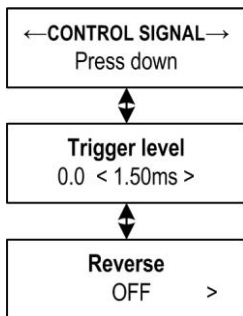

Trigger level – Set the trigger speed for recording of data. For example if the trigger level is 1.50ms and Reverse is OFF, as soon as a speed of 1.50ms is exceeded, then data recording begins and any previously recorded maximum/minimum values are deleted. If the speed is less than the trigger level, no data is recorded and previously recorded data remains unaffected. No acoustic signalling will be given in this case.

If the option SETTING → SPEED MONITOR → BEEP OF SPEED is set to „ON“ and the control wire is not connected, then the acoustic signal will be switched on permanently.

Reverse – Reverse the control signal input.

MAIN – By pressing the down arrow of the Jeti Box, the main menu for MSPEED is displayed, where the units of speed and alarm signal can be programmed.

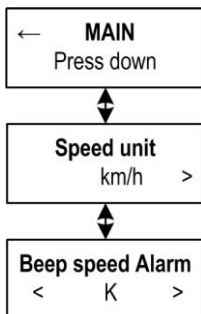

Speed unit – Specify the unit of measurement for speed, as one of:

- km/h – Kilometres per hour
- m/s – Metres per second
- mph – Miles per hour

Beep speed Alarm - Set the more code letter to be represented by the Duplex transmitter module, should the speed sensor signal an alarm condition.

1.6 Alarms

MSPEED MENU: *ALARMS* – By pressing the Down arrow, we can access the alarm settings menu for the speed sensor. Should an alarm condition be reached, the 2nd line of the Jeti Box (If connected) will indicate the condition and the transmitter module will emit an audible alarm according to the morse code character specified in the main settings.

High speed Al. – The speed which if exceeded, will raise an alarm condition.

Low speed Al. – The speed below which an alarm condition should be raised.

Installation

The main MSPEED sensor unit can be placed directly in the fuselage or installed in the wings. Please avoid direct contact of heat sources, such as batteries, controllers and regulators. The pitot tube must be installed outside zones of airflow directly behind propellers. As an example, the pitot tube may be installed on the wing of a single-engined model aeroplane, or on the fuselage of a twin-engined model.

In single engined models, it is advantageous to install the pitot tube at the leading edge of the wing at the chord. In twin or multi-engined models, it is best to install the pitot tube in the nose of the model or at a minimum distance of 2cm from the fuselage side.

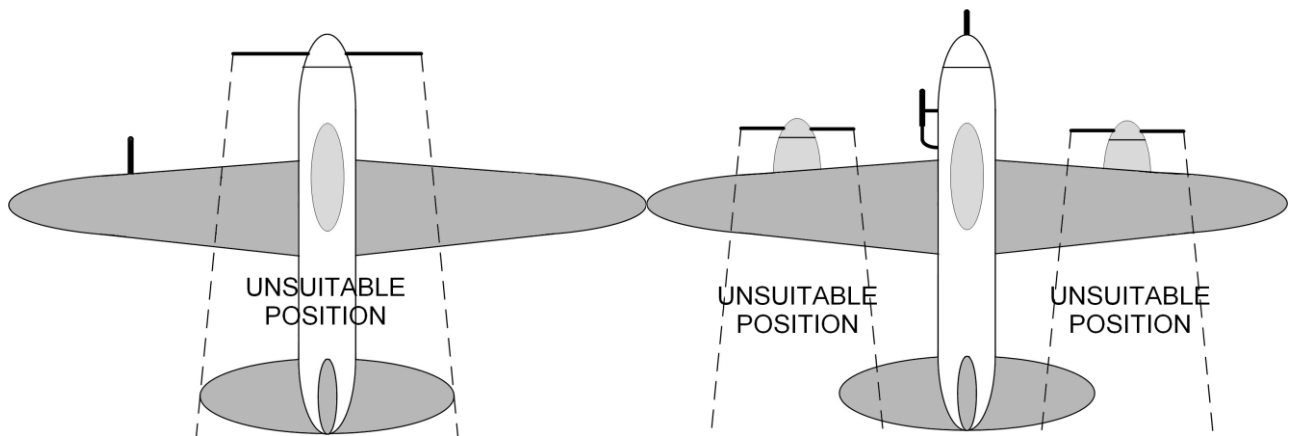

Technical data for MSPEED

Technical Data	MSPEED	MSPEED 450
Sensor unit dimensions (mm)	22x25x13mm	22x25x13mm
Pitot tube dimensions (mm)	54x3 mm	54x3 mm
Weight (complete)	21g	21g
Precision	5 km/h	10 km/h
Limit	20- 300km/h	20- 450km/h
Operating temperature	0-85°C	0-85°C
Operating Voltage	3,5 - 8,4V	3,5 - 8,4V
Current	10mA	10mA

Warranty

A 24-month warranty is provided by the manufacturer from the date of sale on the condition that the unit has been operated within the required voltage limits and there is no physical damage. All servicing during and after the warranty period, is provided by the manufacturer.

Wishing you pleasant flights:
JETI model s.r.o. Příbor, www.jetimodel.cz