

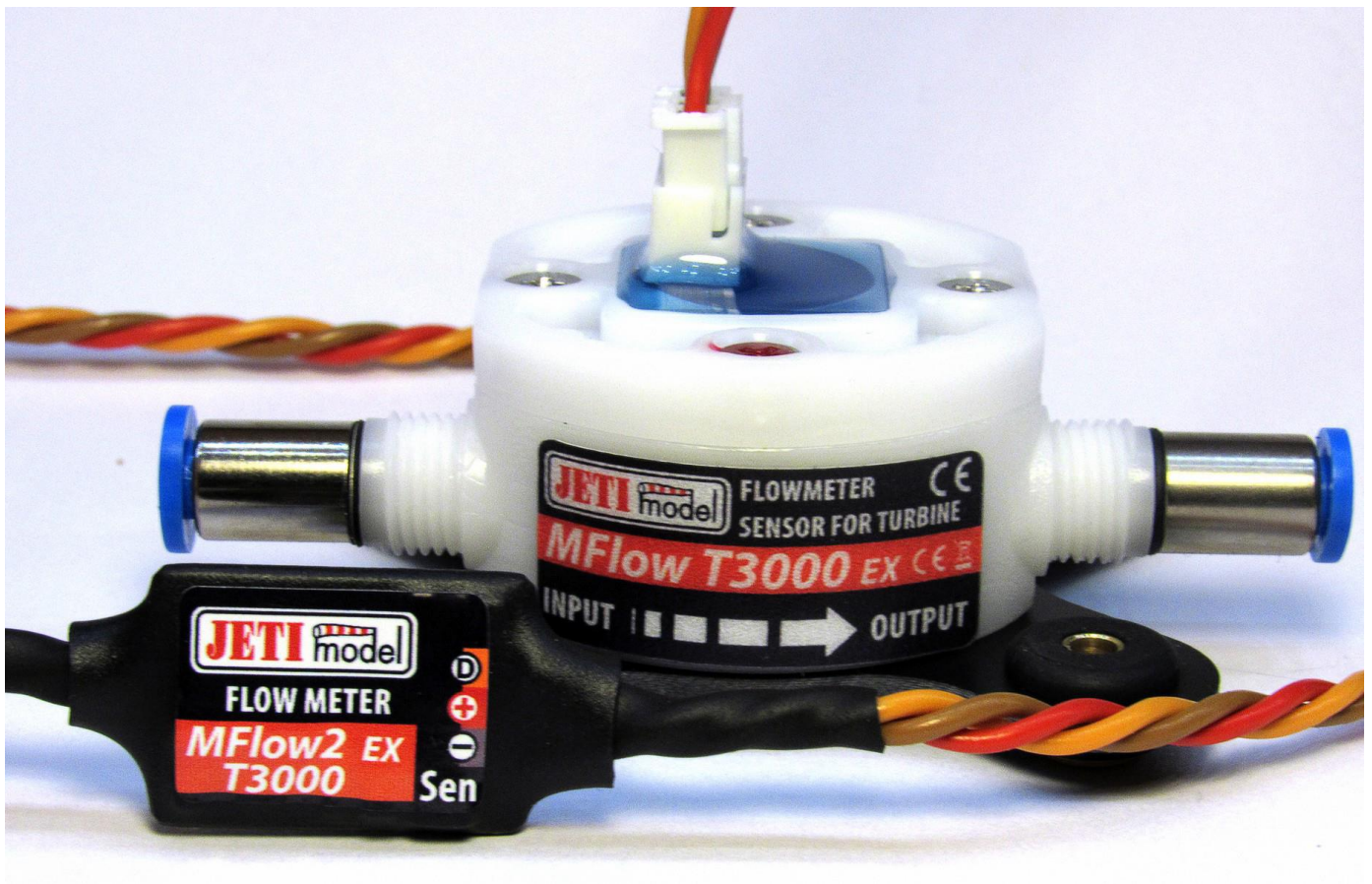

MANUAL

FLOWMETER

MFlow2



CONTENTS

1. INTRODUCTION	3
2. DECSRIPTION.....	3
3. COMMUNICATION OF THE MFLOW2 SENSOR.....	4
4. MFLOW2 MENU	5
5. CONFIGURATION VIA THE DC/DS TRANSMITTER	7
5.1. GENERAL SETTINGS	7
5.2. TELEMETRY	8
6. INSTALLATION.....	8
7. FIRMWARE UPDATE	9
8. TECHNICAL DATA.....	9
9. WARRANTY	9
10. DIAGRAM MENU OF THE JETIBOX.....	10

1. Introduction

The MFlow2 is a telemetry sensor that measures the flow of pumped fuel and calculates the amount of fuel remaining in the tank. There are three versions of the sensor available. The MFlow2-T800(Turbine) and MFlow2-T3000 are versions designed for models powered by a jet engine, the MFlow2-G800(Gasoline) is a version for models powered by glow or gasoline engines. The sensors are adjustable via DC/DS transmitter or via JETIBOX.

- * The sensors are compatible with the Duplex EX system.
- * EX telemetry values: actual flow and the amount of the fuel in the tank.
- * User adjustable parameters such as: tank capacity, depleted fuel alarm, etc.
- * Firmware updates.

2. Description

MFlow2 consists of the flow sensor and the base. The sensor is connected to the base via a cable with a locking connector. The other cable labeled as „Ext“ is used for interface with the DUPLEX system or the JETIBOX. The flow sensor is fitted with these fuel couplers according to type:

- MFlow2-T800 and MFlow2-T3000 2x FESTO for tubes with the external diameter of 4mm
- MFlow2-G800 2x barbed fittings for tubes with the internal diameter of 2 mm and 2x barbed fittings for tubes with the internal diameter of 3 mm

Fuel **flow direction** is labeled on the MFlow2. This direction must be followed for proper measurements.

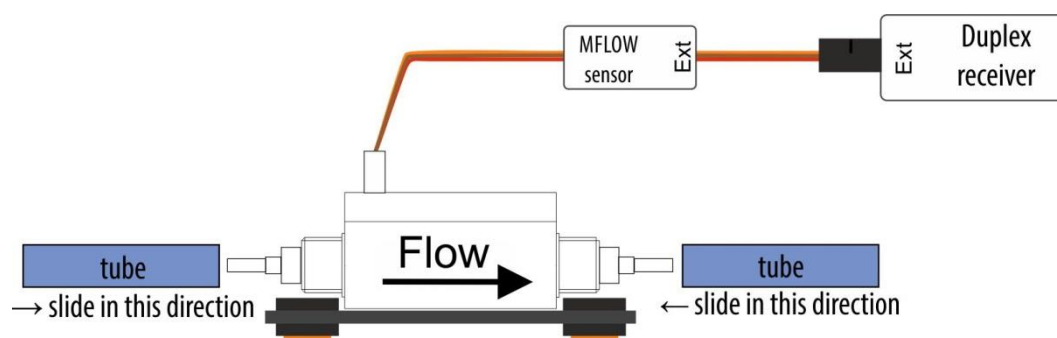
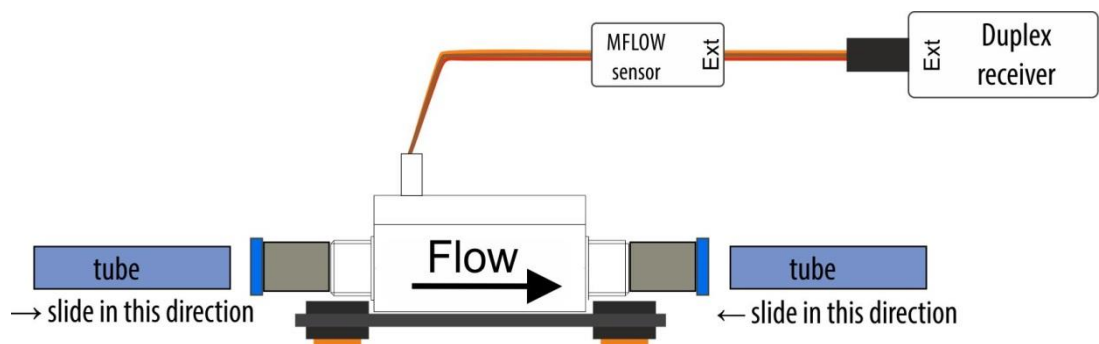

3. Communication of the MFlow2 sensor

- **Connection of the MFlow2 to the JETIBOX**

In this case, it is necessary to use 5 – 8.4V power supply, e.g. receiver batteries. The three-wire cable with the JR (black) connector is connected to the JETIBOX (connector labeled as Impuls, + -). This connection makes it possible to generate alarms, since the siren is a part of the transmitter module that is not connected in this case. The alarms are displayed on the JETIBOX display only.



- **Connection of the MFlow2 to the DUPLEX receiver**

When connected this way, it is possible to connect one MFlow2 sensor powered from the receiver. The three-wire cable with the JR (black) connector is connected to the DUPLEX receiver (via Ext. input).

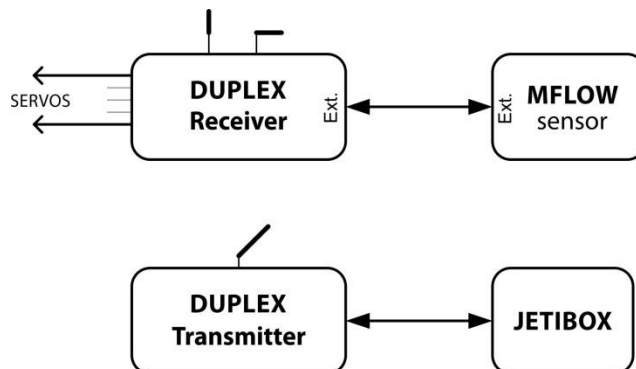

- **Connection of the MFlow2 to the DUPLEX receiver via Expander**

In this case it is possible to process data from more sensors powered from the Expander at the same time. The three-wire cable with the JR (black) connector is connected to the Expander input.

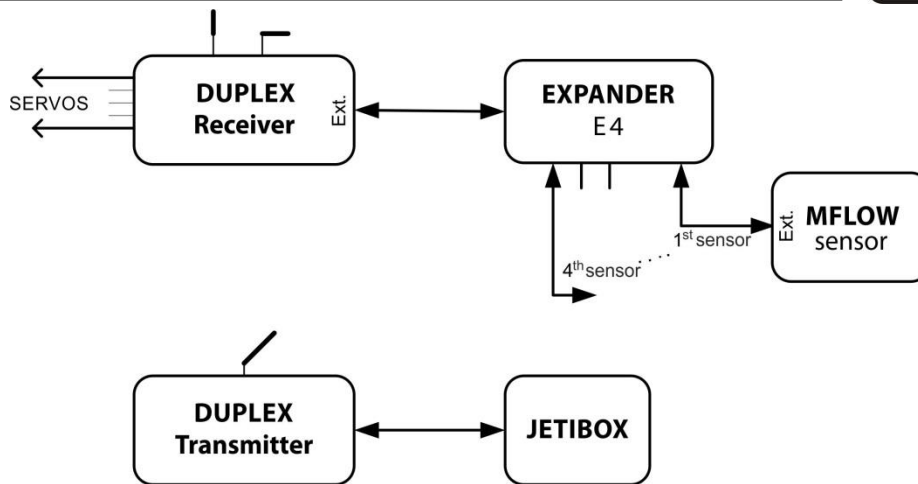

4. MFlow2 Menu

Setting the parameters and reading data is carried out via a JETIBOX. After the MFlow2 is connected (see chapter 3), a welcome screen appears on the JETIBOX display, with the device identification in the first line and with the current flow. The second line consists of a bar graph and the amount of fuel in the tank displayed as a percentage. The bar graph specifying the amount of fuel in the tank consists of ten positions. The amount is signaled by the number of filled positions. „X“ symbol is one step of the bar graph and corresponds with 10% of residual fuel.

Pushing the D button (down) on the JETIBOX gets you to the MFlow2 menu. Pushing the R button (right) for longer time causes a fast reset of all measured parameters.

- ACTUAL VAL.

MFlow2 MENU: *ACTUAL VAL.* – by pushing the D button (arrow down) you select the displaying actual measured values.

Residual volume – depicts actual amount of fuel left in the tank. The total capacity of the tank is set via „SETTING“ → „Tank volume“.

Flow – depicts actual fuel flow.

- AVG / MAX – Averages / Maximums

MFlow2 MENU: *AVG / MAX* – by pushing the D button (arrow down) you select the depiction of the statistical data of fuel flow recorded during the operation. The records are deleted automatically or can be reset manually in *Setting* → *Erase data*. An automatic reset is carried out just once after the device is switched on, precisely when the actual flow exceeds the level set in „SETTING → *Flow trigger*“. If the trigger level is not exceeded after the start, the data from the previous operation is depicted.

MAXIMAL FLOW – shows maximum fuel flow during operation since the last reset.

AVG FLOW – average flow rate during operation since the last reset.

- SETTING

MFlow2 MENU: *SETTING* – pushing the D button (arrow down) gets you to the basic setting of the MFlow2 device.

Reset AVG/MAX – Pressing left and right arrows simultaneously deletes the averages and maximums, see „*AVG / MAX – Averages / Maximums*“.

Tank volume – Setting the capacity of the tank.

Flow trigger – If the fuel flow after switching on does not exceed the set level, the values from previous operation of the sensor are depicted.

The level that initiates the reset of AVG/MAX values and measured tank contents is set in „*Tank volume*“. This automatic setting of the tank contents does not have to be carried out if you select „*Disable*“ in „*Auto reset*“.

Auto erase – the function of automatic reset of the consumed fuel amount after exceeding the „*Flow trigger*“.

- ALARMS

MFlow2 MENU: *ALARMS* – pushing the D button (arrow down) gets you to setting individual alarms. If any set parameter is exceeded, then the JETIBOX display shows in its first line of the welcome screen alternatively the original image and the relevant alarm, and the siren of the transmitter module announces the alarm. The first tone is warning, the second is a Morse code symbol of the relevant alarm.

Volume alarm – setting the alarm for remaining fuel. If the measured tank contents get under this limit, the alarm is activated.

Max. flow alarm – setting the flow alarm. If the actual flow exceeds the set limit, the alarm is activated.

- SERVICE

MFlow2 MENU: *SERVICE* – pushing the D button (arrow down) depicts the firmware version and gives the option for restoring the factory defaults of the device.

PresetToSetup – simultaneously pressing the R and L buttons (right and left) starts factory defaulting of the MFlow device.

MFlow v. xx.xx ID xxxxx:xxxxx – device identification, firmware version, and the serial number (ID).

5. Configuration via the DC/DS transmitter

The MFlow2 can be configured by a DC/DS transmitter via the *Device Explorer* menu. It is necessary to follow these rules for configuring the MFlow2 via transmitter:

- Receiver firmware version Duplex 3.12 and newer (with setting
- Output mode->EX Bus)
- The receiver must be connected to the MFlow2 via EX bus
- Transmitter firmware version 2.02 and newer + the device profile (MFlow2.bin) recorded in the Devices directory on the SD card

When everything is properly connected and configured, the MFLOW2 item appears in the Device Explorer menu. Entering the item moves you to the configuration menu.

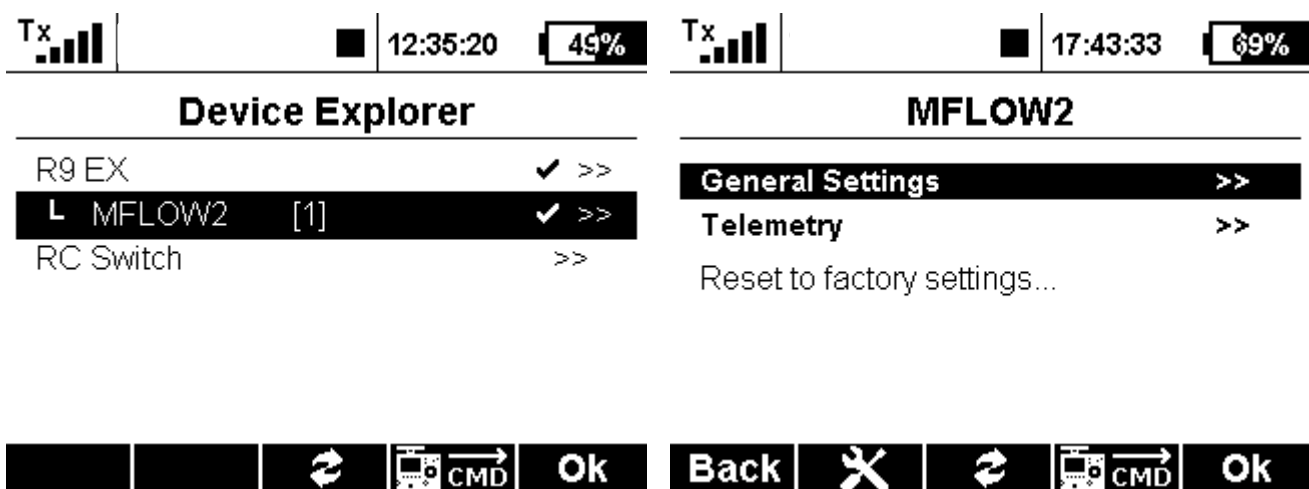

Screenshot 1: Device Explorer (MFlow2)

- **Reset to factory settings** - loading the default settings of the MFlow2

5.1. General settings

- **Clear AVG/Max switch** - here you can assign a control on the DC/DS transmitter which clears average flow and maximal measured flow and resets consumed capacity of the tank and the recorded minimum/maximum values of the SBEC30D.
- **Volume** – Setting the capacity of the tank.
- **Flow Trigger** – If the fuel flow after switching on does not exceed the set level, the values from previous operation of the sensor are depicted.
- **Auto Reset**– the function of automatic reset of the consumed fuel amount after exceeding the „Flow trigger“.

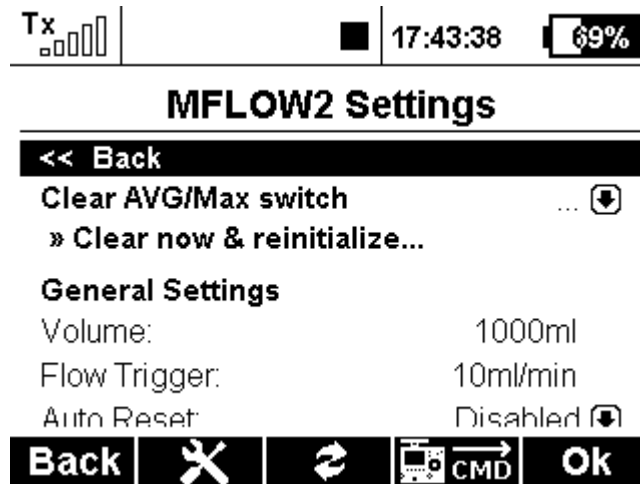

Screenshot 2: Device explorer: Settings

5.2. Telemetry

- *Residual Volume* – depicts actual amount of fuel left in the tank
- *Residual Volume %* – depicts actual amount of fuel left in the tank as a percentage
- *Flow* – depicts actual fuel flow.
- *Maximal Flow*– shows maximum fuel flow during operation since the last reset.
- *Average Flow*– average flow rate during operation since the last reset.

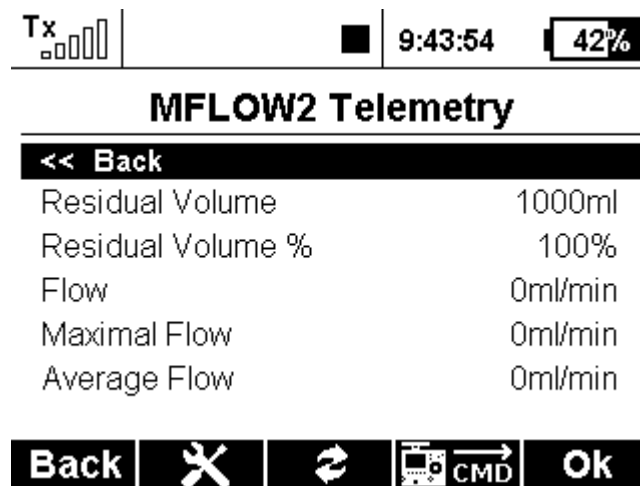

Screenshot 3: Telemetry

6. Installation

Mount the flow detection sensor in a horizontal position in/on the model. The sensor can be mounted to the model using the 4 mounting holes for M3 screws that are placed around the sensor. The sensor must be firmly attached to the model to prevent accidental disconnection of the tubes due to the vibrations of the model. The tubes are connected to the sensor using end-pieces mounted to the

sensor. Always make sure that the tubes are sufficiently pushed onto the sensor end-pieces. The orientation of the sensor is not determined.

7. Firmware update

MFlow2 allows firmware update via a PC. The update is performed using the JETI USBa.

Procedure:

- Find the program to update to the latest firmware on the manufacturer's website under "downloads". Download it to your PC.
- Connect the USB adapter to your computer. The procedure of installing drivers for the USB adapter is to be found in the user manual for the USB adapter.
- Start the firmware update program on your PC.
- Connect the USB adapter via three-wire cable to the main EXT of the MFlow2 (black JR connector).
- When connected, the update of the device starts.

8. Technical data

Technical data	MFlow2-T800	MFlow2-G800	MFlow2-T3000
Measurement range	20-800 ml/min	20-800 ml/min	50-3000 ml/min
Measurement accuracy	±2%	±2%	±2%
Tubing connection	2x Festo Ø4mm	2x barbed fittings Ø2 and Ø3	2x Festo Ø4mm
Dimensions	77x41x30 mm	72x41x30 mm	77x41x30 mm
Weight	40g	40g	40g
Power supply range	5-8.4V	5-8.4V	5-8.4V
Operating temperature range	-20°C-80°C	-20°C-80°C	-20°C-80°C

9. Warranty

For the product we grant a warranty of 24 months from the day of purchase under the assumption that it has been operated in conformity with these instructions at recommended voltages and that it has not been damaged mechanically. Warranty and post warranty service is provided by the manufacturer or your Jeti dealer.

We wish you successful flying with the products of: **JETI model s.r.o. Příbor**, www.jetimodel.cz

10. Diagram menu of the JETIBOX

